

Quantità/Q.ty _____ Riferimento/Reference _____

Data consegna richiesta/Required delivery date _____

TELO/FABRIC
 PVC PRECONSTRAINT 302 COD. _____ SOLTIS W96 COD. _____

 POLIESTERE RESINATO IMPERMEABILE/ WATERPROOF RESIN POLYESTER COD. _____

COLORAZIONI/COLOURS
STRUTTURA/STRUCTURE
 RAL 9010 Bianco White Nero Inver Inver black Altro RAL Other RAL _____

ANODIZZATO / ANODIZED
 Acciaio spazzolato lucido Brushed steel Argento lucido Brilliant Silver Bronzo chiaro Light bronze
 Marrone Brown Testa di moro Dark brown

OPTIONAL
 Tettuccio Hood Kit Luci Light Kit

MOVIMENTAZIONE/MOVEMENT

 Lato motore (vista frontale) Motor side (frontal view) Destro Right Sinistro Left Telecomando Remote control Monocanale Single channel Multicanale Multi-channel

POSA/INSTALLATION
 Parete Wall Soffitto Ceiling

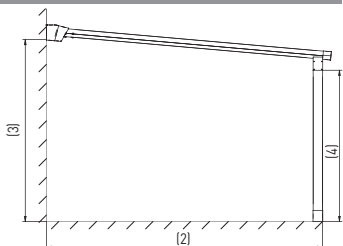
2-3-4 GUIDE/GUIDES

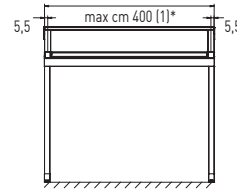
NOTE/NOTES

1 MODULO/MODULE

*500 cm fino a 400 cm di sporgenza / 500 cm till 400 cm of projection

DIMENSIONI/DIMENSIONS

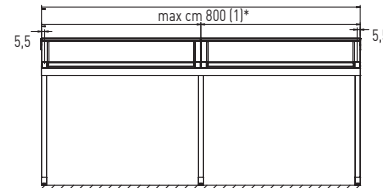
 Larghezza Width (1) cm _____
 Sporgenza Projection (2) cm _____
 Altezza parete Wall height (3) cm _____
 Altezza pilastri Pilar height (4) cm _____
 Altezza soffitto Ceiling height (5) cm _____

2 MODULO/MODULES

*1000 cm fino a 400 cm di sporgenza / 1000 cm till 400 cm of projection

DIMENSIONI/DIMENSIONS

 Larghezza Width (1) cm _____
 Sporgenza Projection (2) cm _____
 Altezza parete Wall height (3) cm _____
 Altezza pilastri Pilar height (4) cm _____
 Altezza soffitto Ceiling height (5) cm _____

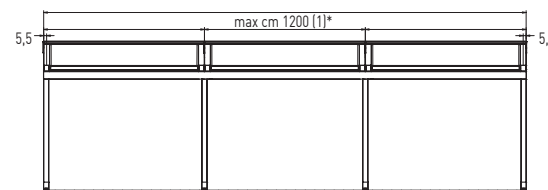
3 MODULO/MODULES

*1500 cm fino a 400 cm di sporgenza / 1500cm till 400 cm of projection

DIMENSIONI/DIMENSIONS

 Larghezza Width (1) cm _____
 Sporgenza Projection (2) cm _____
 Altezza parete Wall height (3) cm _____
 Altezza pilastri Pilar height (4) cm _____
 Altezza soffitto Ceiling height (5) cm _____

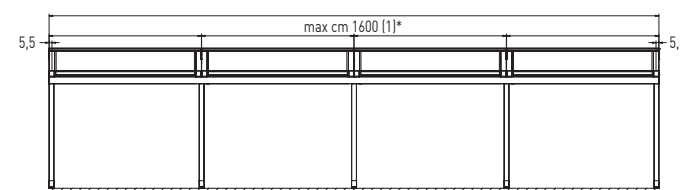
4 MODULO/MODULES

*2000 cm fino a 400 cm di sporgenza / 2000cm till 400 cm of projection

DIMENSIONI/DIMENSIONS

 Larghezza Width (1) cm _____
 Sporgenza Projection (2) cm _____
 Altezza parete Wall height (3) cm _____
 Altezza pilastri Pilar height (4) cm _____
 Altezza soffitto Ceiling height (5) cm _____

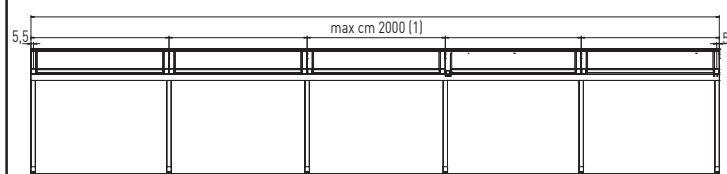
5 MODULO/MODULES

*2500 cm fino a 400 cm di sporgenza / 2500cm till 400 cm of projection

DIMENSIONI/DIMENSIONS

 Larghezza Width (1) cm _____
 Sporgenza Projection (2) cm _____
 Altezza parete Wall height (3) cm _____
 Altezza pilastri Pilar height (4) cm _____
 Altezza soffitto Ceiling height (5) cm _____

CLIENTE (timbro) CUSTOMER (stamp)

 Quantità/Q.ty _____ Riferimento/Reference _____

 Data consegna richiesta/Required delivery date _____

COLORAZIONI/COLOURS
STRUTTURA/STRUCTURE
 RAL 9010 Bianco White Nero Inver Inver black

 Altro RAL _____
 Other RAL _____

MOVIMENTAZIONE/MOVEMENT

 Telecomando Remote control Teleco/KE Somfy Telis 1

 Somfy Telis 4 Somfy Telis 16

OPTIONAL
 Sensore vento radio Radio wind sensor Sensore pioggia Rain sensor Kit Luci Light Kit

 Sensore temperatura Temperature sensor Piastra a terra per piedino Blades perpendicular to the wall

 Sensore neve Snow sensor Bridge (obbligatorio con telecomando Somfy) Bridge (remote control Somfy obligatory)

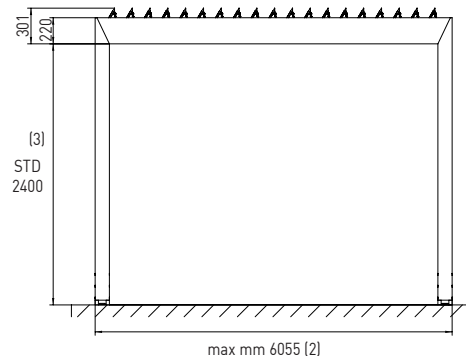
4 MONTANTI/PILLARS

DIMENSIONI/DIMENSIONS

Larghezza Width (1) cm _____

Sporgenza Projection (2) cm _____

Altezza pilastri Pilar height (3) cm _____

Lato inclinazione lame Blades inclination side (4) cm _____

Verso rotazione lame Blades rotation direction (5) cm _____

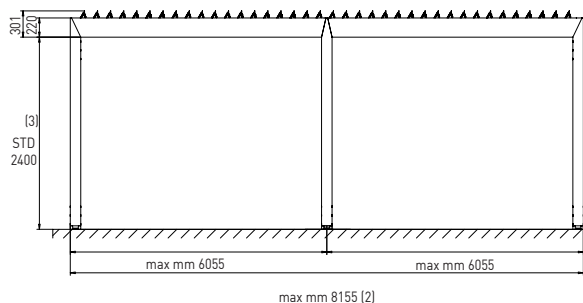
6 MONTANTI/PILLARS

DIMENSIONI/DIMENSIONS

Larghezza Width (1) cm _____

Sporgenza Projection (2) cm _____

Altezza pilastri Pilar height (3) cm _____

Lato inclinazione lame Blades inclination side (4) cm _____

Verso rotazione lame Blades rotation direction (5) cm _____

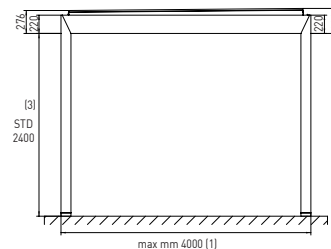
4-6 MONTANTI/PILLARS

NOTE/NOTES

CLIENTE (timbro) CUSTOMER (stamp)

Quantità/Q.ty _____ Riferimento/Reference _____

Data consegna richiesta/Required delivery date _____

ORIENTAMENTO LAME/BLADES ORIENTATION

- Parallele alla parete Parallel to the wall
- Perpendicolari alla parete Perpendicular to the wall

COLORAZIONI/COLOURS STRUTTURA/STRUCTURE

- RAL 9010 Bianco White
- Nero Inver Inver black

- Altro RAL _____
Other RAL _____

MOVIMENTAZIONE/MOVEMENT

- Telecomando Remote control
- Teleco/KE
- Somfy Telis 1
- Somfy Telis 4
- Somfy Telis 16

OPTIONAL

- Sensore vento radio Radio wind sensor
- Sensore pioggia Rain sensor
- Kit Luci Light Kit
- Sensore temperatura Temperature sensor
- Piastra a terra per piedino Blades perpendicular to the wall
- Sensore neve Snow sensor
- Bridge (obbligatorio con telecomando Somfy) Bridge (remote control Somfy obligatory)

2 MONTANTI/PILLARS

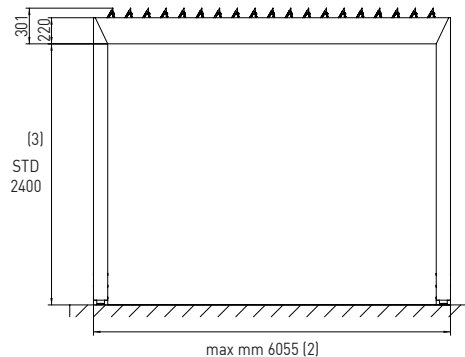

DIMENSIONI/DIMENSIONS

- Larghezza Width (1) cm _____
- Sporgenza Projection (2) cm _____
- Altezza pilastri Pilar height (3) cm _____
- Lato inclinazione lame Blades inclination side (4) cm _____
- Verso rotazione lame Blades rotation direction (5) cm _____

4 MONTANTI/PILLARS

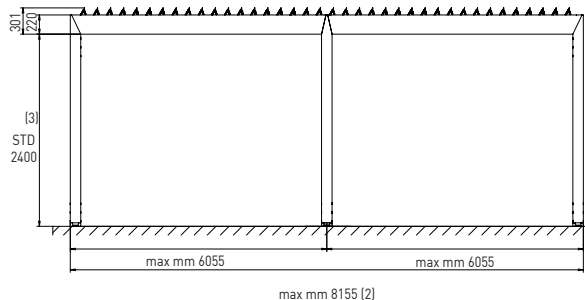

DIMENSIONI/DIMENSIONS

- Larghezza Width (1) cm _____
- Sporgenza Projection (2) cm _____
- Altezza pilastri Pilar height (3) cm _____
- Lato inclinazione lame Blades inclination side (4) cm _____
- Verso rotazione lame Blades rotation direction (5) cm _____

2-4 MONTANTI/PILLARS

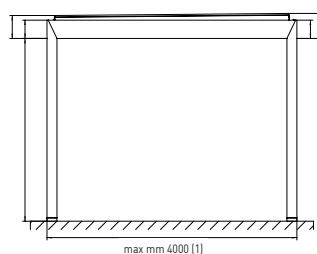

NOTE/NOTES

CLIENTE (timbro) CUSTOMER (stamp)

Quantità/Q.ty _____ Riferimento/Reference _____

Data consegna richiesta/Required delivery date _____

COLORAZIONI/COLOURS

STRUTTURA/STRUCTURE

RAL 9010 Bianco
White

Nero Inver
Inver black

Altro RAL _____
Other RAL

MOVIMENTAZIONE/MOUMENT

Telecomando
Remote control Teleco/KE

Somfy Telis 1

Somfy Telis 4

Somfy Telis 16

OPTIONAL

Sensore vento radio
Radio wind sensor

Sensore pioggia
Rain sensor

Sensore temperatura
Temperature sensor

Piastra a terra per piedino
Blades perpendicular to the wall

Sensore neve
Snow sensor

Bridge (obbligatorio con telecomando Somfy)
Bridge (remote control Somfy obligatory)

DIMENSIONI/DIMENSIONS

Larghezza
Width (1) cm _____

Lato inclinazione lame
Blades inclination side (3) cm _____

Sporgenza
Projection (2) cm _____

Verso rotazione lame
Blades rotation direction (4) cm _____

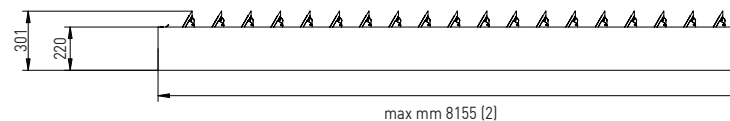
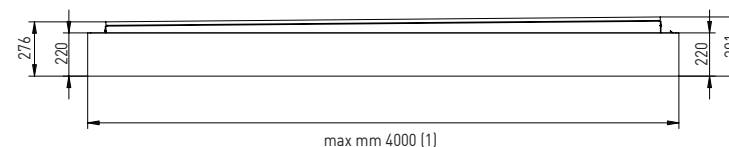

NOTE/NOTES

CLIENTE (timbro) CUSTOMER (stamp)

Quantità/Q.ty _____ Riferimento/Reference _____

Data consegna richiesta/Required delivery date _____

COLORAZIONI/COLOURS
STRUTTURA/STRUCTURE

RAL 9010 Bianco White Nero Inver Inver black

Altro RAL _____
Other RAL

MOVIMENTAZIONE/MOVEMENT

Telecomando Remote control Teleco/KE Somfy Telis 1

Somfy Telis 4 Somfy Telis 16

OPTIONAL

Sensore vento radio Radio wind sensor Sensore pioggia Rain sensor Kit Luci Light Kit

Sensore temperatura Temperature sensor Piastra a terra per piedino Blades perpendicular to the wall

Sensore neve Snow sensor Bridge (obbligatorio con telecomando Somfy) Bridge (remote control Somfy obligatory)

4 MONTANTI/PILLARS

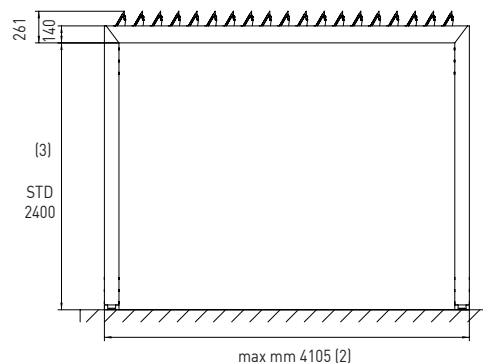

DIMENSIONI/DIMENSIONS

Larghezza Width (1) cm _____

Sporgenza Projection (2) cm _____

Altezza pilastri Pilar height (3) cm _____

Lato inclinazione lame Blades inclination side (4) cm _____

Verso rotazione lame Blades rotation direction (5) cm _____

6 MONTANTI/PILLARS

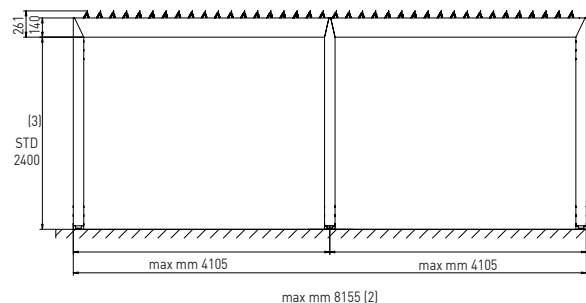

DIMENSIONI/DIMENSIONS

Larghezza Width (1) cm _____

Sporgenza Projection (2) cm _____

Altezza pilastri Pilar height (3) cm _____

Lato inclinazione lame Blades inclination side (4) cm _____

Verso rotazione lame Blades rotation direction (5) cm _____

4-6 MONTANTI/PILLARS

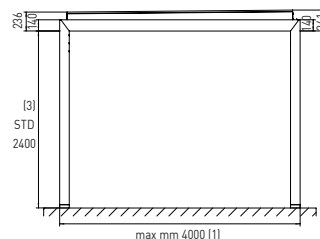

NOTE/NOTES

CLIENTE (timbro) CUSTOMER (stamp)

Quantità/Q.ty

Riferimento/Reference

Data consegna richiesta/Required delivery date

ORIENTAMENTO LAME/BLADES ORIENTATION

Parallele alla parete
Parallel to the wall

Perpendicolari alla parete
Perpendicular to the wall

COLORAZIONI/COLOURS STRUTTURA/STRUCTURE

RAL 9010 Bianco
White

Nero Inver
Inver black

Altro RAL _____
Other RAL

MOVIMENTAZIONE/MOVEMENT

Telecomando
Remote control

Teleco/KE

Somfy Telis 1

Somfy Telis 4

Somfy Telis 16

OPTIONAL

Sensore vento radio
Radio wind sensor

Sensore pioggia
Rain sensor

Kit Luci
Light Kit

Sensore temperatura
Temperature sensor

Piastra a terra per piedino
Blades perpendicular to the wall

Sensore neve
Snow sensor

Bridge (obbligatorio con telecomando Somfy)
Bridge (remote control Somfy obligatory)

2 MONTANTI/PILLARS

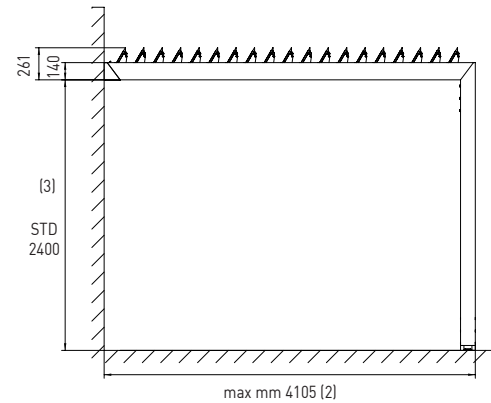

DIMENSIONI/DIMENSIONS

Larghezza
Width (1) cm _____

Sporgenza
Projection (2) cm _____

Altezza pilastri
Pilar height (3) cm _____

Lato inclinazione lame
Blades inclination side (4) cm _____

Verso rotazione lame
Blades rotation direction (5) cm _____

4 MONTANTI/PILLARS

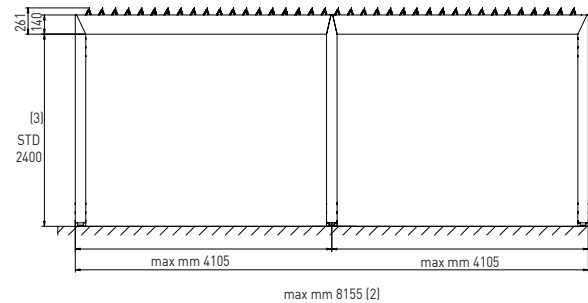

DIMENSIONI/DIMENSIONS

Larghezza
Width (1) cm _____

Sporgenza
Projection (2) cm _____

Altezza pilastri
Pilar height (3) cm _____

Lato inclinazione lame
Blades inclination side (4) cm _____

Verso rotazione lame
Blades rotation direction (5) cm _____

2-4 MONTANTI/PILLARS

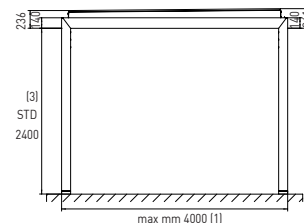

NOTE/NOTES

CLIENTE (timbro) CUSTOMER (stamp)

Quantità/Q.ty _____ Riferimento/Reference _____

Data consegna richiesta/Required delivery date _____

TELO/FABRIC

- | | |
|---|--|
| <input type="checkbox"/> PVC PRECONTRAIKT 602 | oscurante Bianco Opaco
black out matt white |
| <input type="checkbox"/> PVC PRECONTRAIKT 602 | oscurante Avorio Opaco
black out matt ivory |
| <input type="checkbox"/> PVC PRECONTRAIKT 602 | Bianco
White |
| <input type="checkbox"/> PVC PRECONTRAIKT 602 | Avorio
Ivory |
| <input type="checkbox"/> Altro/Other | _____ |

TELO LASCO/SLACK FABRIC

- | |
|--|
| <input type="checkbox"/> Parallelo
Parallel |
| <input type="checkbox"/> Alternato
Alternated |
| <input type="checkbox"/> Asimmetrico
Asymmetrical |

COLORAZIONI/COLOURS
GUIDE/GUIDES

- | |
|---|
| <input type="checkbox"/> RAL 9010 Bianco
White |
| <input type="checkbox"/> RAL 1013 Avorio
Ivory |
| <input type="checkbox"/> RAL 8014 Marrone opaco
Matt Brown |
| <input type="checkbox"/> Altro
Other colour _____ |

TRAVERSI/CROSSBAR PROFILES

- | |
|--|
| <input type="checkbox"/> RAL 9010 Bianco
White |
| <input type="checkbox"/> RAL 1013 Avorio
Ivory |
| <input type="checkbox"/> Altro
Other colour _____ |

OPTIONAL

- | | | | |
|--|--|---|--|
| <input type="checkbox"/> Guarnizione antipioggia
Drain gasket | <input type="checkbox"/> Tettuccio RAL 9010
Hood RAL 9010 | <input type="checkbox"/> Kit Luci
Lights Kit | <input type="checkbox"/> Tettuccio RAL 1013
Hood RAL 1013 |
|--|--|---|--|

MOVIMENTAZIONE/MOVEMENT

*Solo per modello 2 GUIDE/Only for 2-guides-model

- | | | |
|---|---|---|
| <input type="checkbox"/> Manuale* Asta
Manual* with crank rod cm _____ | Lato (vista frontale)
Side (frontal side) _____ | |
| <input type="checkbox"/> Motorizzazione KE
KE Motorization | <input type="checkbox"/> Motorizzazione SOMFY
SOMFY Motorization | |
| <input type="checkbox"/> Motorizzazione SUNILUS IO
SUNILUS IO Motorization | <input type="checkbox"/> Motorizzazione PERGOLA IO
PERGOLA IO Motorization | |
| Telecomando
Remote control | <input type="checkbox"/> Monocanale
Single channel | <input type="checkbox"/> Multicanale
Multi-channel |

STAFFE/BRACKETS

- | | |
|---|--|
| <input type="checkbox"/> Per applicazione a parete
For wall installation | <input type="checkbox"/> Per applicazione a soffitto
For ceiling installation |
| <input type="checkbox"/> Per inclinazione
For inclination | <input type="checkbox"/> Parete A1+frontale di rinvio
A1wall+front reference |

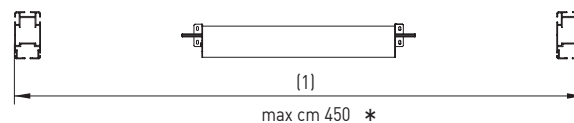
2 GUIDE/GUIDES

DIMENSIONI/DIMENSIONS

 Larghezza guide (1) cm _____
Guide width

 Lunghezza guide (4) cm _____
Guide length

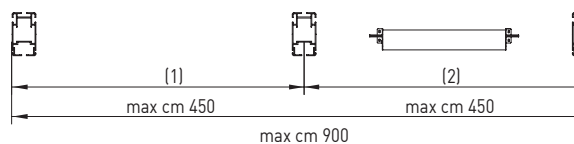
*500 cm fino a 500 cm di sporgenza / 500 cm till 500 cm of projection

3 GUIDE/GUIDES

DIMENSIONI/DIMENSIONS

 Larghezza guide (1) cm _____
Guide width

 Larghezza guide (2) cm _____
Guide width

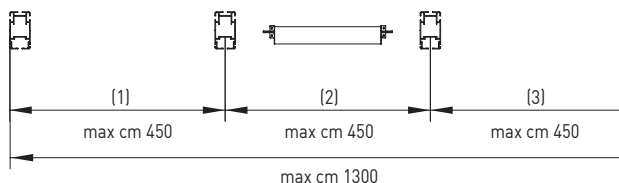
 Lunghezza guide (4) cm _____
Guide length

4 GUIDE/GUIDES

DIMENSIONI/DIMENSIONS

 Larghezza guide (1) cm _____
Guide width

 Larghezza guide (2) cm _____
Guide width

 Larghezza guide (3) cm _____
Guide width

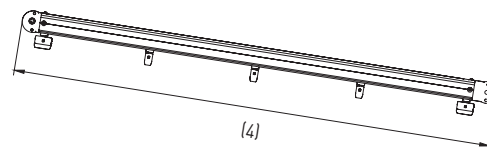
 Lunghezza guide (4) cm _____
Guide length

2-3-4 GUIDE/GUIDES
**LUNGHEZZA GUIDE
GUIDE LENGTH**

NOTE/NOTES

CLIENTE (timbro) CUSTOMER (stamp)

Quantità/Q.ty _____ Riferimento/Reference _____

Data consegna richiesta/Required delivery date _____

TELO/FABRIC

- | | |
|--|--|
| <input type="checkbox"/> PVC PRECONTRAI NT 602 | oscurante Bianco Opaco
black out matt white |
| <input type="checkbox"/> PVC PRECONTRAI NT 602 | oscurante Avorio Opaco
black out matt ivory |
| <input type="checkbox"/> PVC PRECONTRAI NT 602 | Bianco
White |
| <input type="checkbox"/> PVC PRECONTRAI NT 602 | Avorio
Ivory |
| <input type="checkbox"/> Altro/Other | _____ |

TELO LASCO/SLACK FABRIC

- | |
|--|
| <input type="checkbox"/> Parallelo
Parallel |
| <input type="checkbox"/> Alternato
Alternated |
| <input type="checkbox"/> Asimmetrico
Asymmetrical |

COLORAZIONI/COLOURS
STRUTTURA/STRUCTURE

- | |
|--|
| <input type="checkbox"/> RAL 9010 Bianco
White |
| <input type="checkbox"/> RAL 1013 Avorio
Ivory |
| <input type="checkbox"/> Nero Inver
Inver Black |
| <input type="checkbox"/> Altro
Other colour _____ |

TRAVERSI/CROSSBAR PROFILES

- | |
|--|
| <input type="checkbox"/> RAL 9010 Bianco
White |
| <input type="checkbox"/> RAL 1013 Avorio
Ivory |
| <input type="checkbox"/> Altro
Other colour _____ |

OPTIONAL

- | | | |
|--|---|--|
| <input type="checkbox"/> Guarnizione antipioggia
Drain gasket | <input type="checkbox"/> Tettuccio
Hood RAL 9010 | <input type="checkbox"/> Kit Luci
Light Kit |
| <input type="checkbox"/> Pluviale mobile
Downpipe mobile | <input type="checkbox"/> Tettuccio
Hood RAL 1013 | |

MOVIMENTAZIONE/MOVEMENT

- | | |
|---|---|
| <input type="checkbox"/> Motorizzazione KE
KE Motorization | <input type="checkbox"/> Motorizzazione SOMFY
SOMFY Motorization |
| <input type="checkbox"/> Motorizzazione SUNILUS IO
SUNILUS IO Motorization | <input type="checkbox"/> Motorizzazione PERGOLA IO
PERGOLA IO Motorization |
| <input type="checkbox"/> Telecomando
Remote control | <input type="checkbox"/> Monocanale
Single channel |
| | <input type="checkbox"/> Multicanale
Multi-channel |

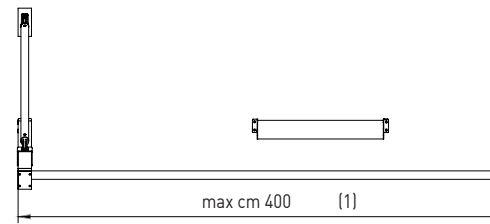
2 GUIDE/GUIDES

DIMENSIONI/DIMENSIONS

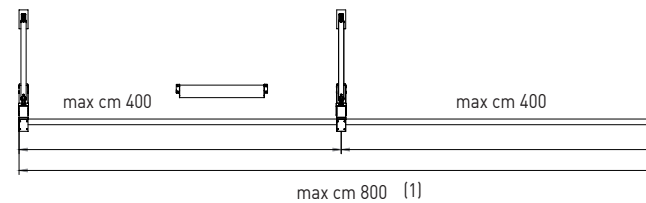
- | | | |
|---|--------|-------|
| Larghezza
Width | (1) cm | _____ |
| Sporgenza SP
Projection SP | (2) cm | _____ |
| Altezza parete H2
Wall height H2 | (3) cm | _____ |
| Altezza frontale H1
Frontal height H1 | (4) cm | _____ |
| Distanza staffe H3
H3 support distance | (5) cm | _____ |

3 GUIDE/GUIDES

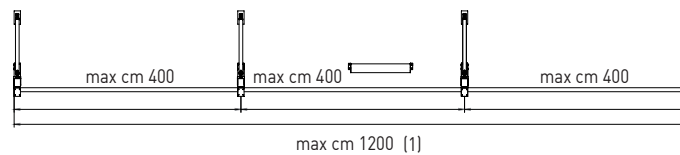
DIMENSIONI/DIMENSIONS

- | | | |
|---|--------|-------|
| Larghezza
width | (1) cm | _____ |
| Sporgenza SP
Projection SP | (2) cm | _____ |
| Altezza parete H2
Wall height H2 | (3) cm | _____ |
| Altezza frontale H1
Frontal height H1 | (4) cm | _____ |
| Distanza staffe H3
H3 support distance | (5) cm | _____ |

4 GUIDE/GUIDES

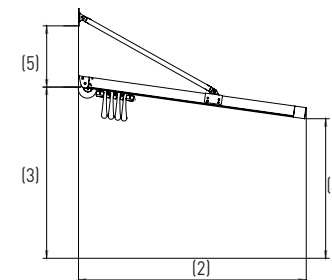
DIMENSIONI/DIMENSIONS

- | | | |
|---|--------|-------|
| Larghezza
width | (1) cm | _____ |
| Sporgenza SP
Projection SP | (2) cm | _____ |
| Altezza parete H2
Wall height H2 | (3) cm | _____ |
| Altezza frontale H1
Frontal height H1 | (4) cm | _____ |
| Distanza staffe H3
H3 support distance | (5) cm | _____ |

2-3-4 GUIDE/GUIDES
**LUNGHEZZA GUIDE
GUIDE LENGTH**

NOTE/NOTES

CLIENTE (timbro) CUSTOMER (stamp)

Quantità/Q.ty _____	Riferimento/Reference _____
---------------------	-----------------------------

Data consegna richiesta/Required delivery date _____

TELO/FABRIC

- | | |
|--|--|
| <input type="checkbox"/> PVC PRECONTRAI NT 602 | oscurante Bianco Opaco
black out matt white |
| <input type="checkbox"/> PVC PRECONTRAI NT 602 | oscurante Avorio Opaco
black out matt ivory |
| <input type="checkbox"/> PVC PRECONTRAI NT 602 | Bianco
White |
| <input type="checkbox"/> PVC PRECONTRAI NT 602 | Avorio
Ivory |
| <input type="checkbox"/> Altro/Other | _____ |

TELO LASCO/SLACK FABRIC

- | |
|--|
| <input type="checkbox"/> Parallelo
Parallel |
| <input type="checkbox"/> Alternato
Alternated |
| <input type="checkbox"/> Asimmetrico
Asymmetrical |

COLORAZIONI/COLOURS
STRUTTURA/STRUCTURE

- | |
|--|
| <input type="checkbox"/> RAL 9010 Bianco
White |
| <input type="checkbox"/> RAL 1013 Avorio
Ivory |
| <input type="checkbox"/> Nero Inver
Inver Black |
| <input type="checkbox"/> Altro
Other colour _____ |

TRAVERSI/CROSSBAR PROFILES

- | |
|--|
| <input type="checkbox"/> RAL 9010 Bianco
White |
| <input type="checkbox"/> RAL 1013 Avorio
Ivory |
| <input type="checkbox"/> Altro
Other colour _____ |

OPTIONAL

- | | | |
|---|---|--|
| <input type="checkbox"/> Guarnizione anti-pioggia
Drain gasket | <input type="checkbox"/> Tettuccio RAL 9010
Hood | <input type="checkbox"/> Kit Luci
Light Kit |
| <input type="checkbox"/> Pluviale mobile
Downpipe mobile | <input type="checkbox"/> Tettuccio RAL 1013
Hood | |

MOVIMENTAZIONE/MOVEMENT

- | | |
|---|---|
| <input type="checkbox"/> Motorizzazione KE
KE Motorization | <input type="checkbox"/> Motorizzazione SOMFY
SOMFY Motorization |
| <input type="checkbox"/> Motorizzazione SUNILUS IO
SUNILUS IO Motorization | <input type="checkbox"/> Motorizzazione PERGOLA IO
PERGOLA IO Motorization |
| <input type="checkbox"/> Telecomando
Remote control | <input type="checkbox"/> Monocanale
Single channel |
| | <input type="checkbox"/> Multicanale
Multi-channel |

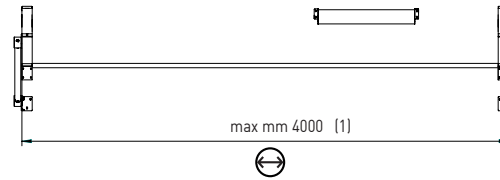
MODULO SINGOLO/SINGLE MODULE

DIMENSIONI/DIMENSIONS

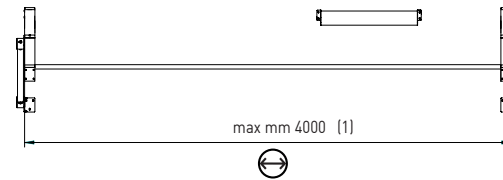
- | | | |
|---|--------|-------|
| Larghezza
Width | (1) cm | _____ |
| Sporgenza SP
Projection SP | (2) cm | _____ |
| Altezza parete H2
Wall height H2 | (3) cm | _____ |
| Altezza frontale H1
Frontal height H1 | (4) cm | _____ |
| Distanza staffe H3
H3 support distance | (5) cm | _____ |

MODULO AGGIUNTO/ADJUNCT MODULE

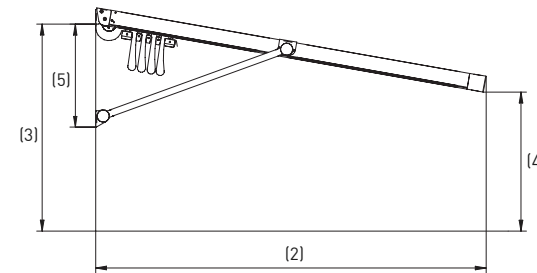
DIMENSIONI/DIMENSIONS

- | | | |
|---|--------|-------|
| Larghezza
width | (1) cm | _____ |
| Sporgenza SP
Projection SP | (2) cm | _____ |
| Altezza parete H2
Wall height H2 | (3) cm | _____ |
| Altezza frontale H1
Frontal height H1 | (4) cm | _____ |
| Distanza staffe H3
H3 support distance | (5) cm | _____ |

**LUNGHEZZA GUIDE
GUIDE LENGTH**

NOTE/NOTES

CLIENTE (timbro) CUSTOMER (stamp)

Quantità/Q.ty _____ Riferimento/Reference _____

Data consegna richiesta/Required delivery date _____

TELO/FABRIC

- PVC PRECONTRAIKT 602 oscurante Bianco Opaco
black out matt white
- PVC PRECONTRAIKT 602 oscurante Avorio Opaco
black out matt ivory
- PVC PRECONTRAIKT 602 Bianco
White
- PVC PRECONTRAIKT 602 Avorio
Ivory
- Altro/Other _____

TELO LASCO/SLACK FABRIC

- Parallelo
Parallel
- Alternato
Alternated
- Asimmetrico
Asymmetrical

COLORAZIONI/COLOURS

STRUTTURA/STRUCTURE

- RAL 9010 Bianco
White
- RAL 1013 Avorio
Ivory
- RAL 8014 Marrone opaco
Matt brown
- Altro
Other colour _____

TRAVERSI/CROSSBAR PROFILES

- RAL 9010 Bianco
White
- RAL 1013 Avorio
Ivory
- Altro
Other colour _____

OPTIONAL

- Guarnizione anti-pioggia
Drain gasket
- Grondaia
Gutter
- Kit Luci
Light Kit
- Tettuccio RAL 9010
Hood
- Tettuccio RAL 1013
Hood

MOVIMENTAZIONE/MOVEMENT

*Solo per modello 2 GUIDE/Only for 2-guides-model

- Manuale* Asta
Manual*with crank rod cm _____ Lato (vista frontale)
Side (frontal side) _____
- Motorizzazione KE
KE Motorization
- Motorizzazione SOMFY
SOMFY Motorization
- Motorizzazione SUNILUS IO
SUNILUS IO Motorization
- Motorizzazione PERGOLA IO
PERGOLA IO Motorization
- Telecomando Remote control Monocanale
Single channel Multicanale
Multi-channel

POSA/INSTALLATION

- Parete
Wall
- Soffitto
Ceiling

2 GUIDE/GUIDES

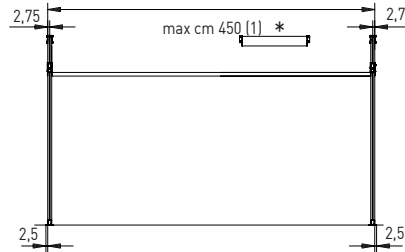

*500 cm fino a 500 cm di sporgenza / 500 cm till 500 cm of projection

DIMENSIONI/DIMENSIONS

- Larghezza Width (1) cm _____
- Sporgenza Projection (2) cm _____
- Altezza parete Wall height (3) cm _____
- Altezza pilastri Pilar height (4) cm _____
- Altezza soffitto Ceiling height (5) cm _____

3 GUIDE/GUIDES

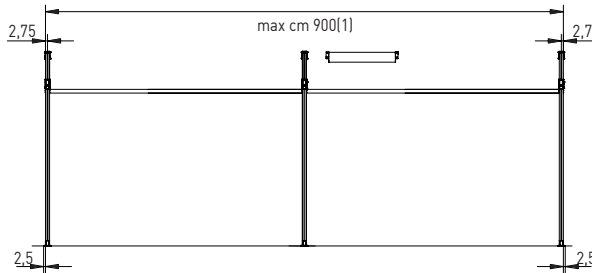

DIMENSIONI/DIMENSIONS

- Larghezza Width (1) cm _____
- Sporgenza Projection (2) cm _____
- Altezza parete Wall height (3) cm _____
- Altezza pilastri Pilar height (4) cm _____
- Altezza soffitto Ceiling height (5) cm _____

4 GUIDE/GUIDES

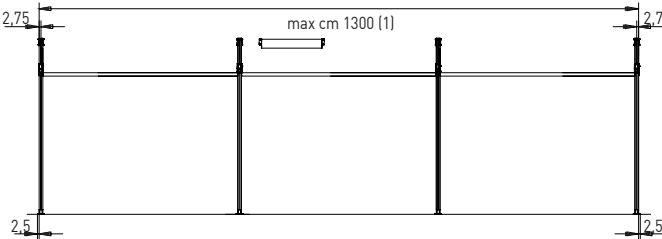

DIMENSIONI/DIMENSIONS

- Larghezza Width (1) cm _____
- Sporgenza Projection (2) cm _____
- Altezza parete Wall height (3) cm _____
- Altezza pilastri Pilar height (4) cm _____
- Altezza soffitto Ceiling height (5) cm _____

2-3-4 GUIDE/GUIDES

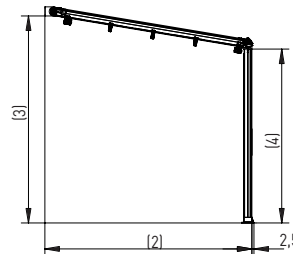

NOTE/NOTES

CLIENTE (timbro) CUSTOMER (stamp)

Quantità/Q.ty _____ Riferimento/Reference _____

Data consegna richiesta/Required delivery date _____

TELO/FABRIC

- | | |
|---|--|
| <input type="checkbox"/> PVC PRECONTRAIKT 602 | oscurante Bianco Opaco
black out matt white |
| <input type="checkbox"/> PVC PRECONTRAIKT 602 | oscurante Avorio Opaco
black out matt ivory |
| <input type="checkbox"/> PVC PRECONTRAIKT 602 | Bianco
White |
| <input type="checkbox"/> PVC PRECONTRAIKT 602 | Avorio
Ivory |
| <input type="checkbox"/> Altro/Other | _____ |

TELO LASCO/SLACK FABRIC

- | |
|--|
| <input type="checkbox"/> Parallelo
Parallel |
| <input type="checkbox"/> Alternato
Alternated |
| <input type="checkbox"/> Asimmetrico
Asymmetrical |

COLORAZIONI/COLOURS

STRUTTURA/STRUCTURE

- | | |
|---|---|
| <input type="checkbox"/> RAL 9010 Bianco
White | <input type="checkbox"/> Nero Inver
Inver black |
| <input type="checkbox"/> RAL 1013 Avorio
Ivory | <input type="checkbox"/> Altro RAL
Other RAL _____ |
| <input type="checkbox"/> RAL 8014 Marrone opaco
Matt brown | |

ANODIZZATO / ANODIZED

- | | | |
|---|---|--|
| <input type="checkbox"/> Acciaio spazzolato lucido
Brushed steel | <input type="checkbox"/> Argento lucido
Brilliant Silver | <input type="checkbox"/> Bronzo chiaro
Light bronze |
| <input type="checkbox"/> Marrone
Brown | <input type="checkbox"/> Testa di moro
Dark brown | |

TRAVERSI/CROSSBAR PROFILES

- | | | |
|-----------------------------------|-----------------------------------|---|
| <input type="checkbox"/> RAL 9010 | <input type="checkbox"/> RAL 1013 | <input type="checkbox"/> Altro
Other _____ |
|-----------------------------------|-----------------------------------|---|

OPTIONAL

- | | | | |
|--|---|---|---|
| <input type="checkbox"/> Guarnizione antipioggia
Drain gasket | <input type="checkbox"/> Tettuccio RAL 9010
Hood | <input type="checkbox"/> Tettuccio RAL 1013
Hood | <input type="checkbox"/> Kit Luci
Lights Kit |
|--|---|---|---|

MOVIMENTAZIONE/MOVEMENT

*Solo per modello 2 GUIDE/Only for 2-guides-model

- | | |
|---|---|
| <input type="checkbox"/> Manuale* Asta
Manual*with crank rod cm _____ | <input type="checkbox"/> Lato (vista frontale)
Side (frontal side) _____ |
| <input type="checkbox"/> Motorizzazione KE
KE Motorization | <input type="checkbox"/> Motorizzazione SOMFY
SOMFY Motorization |
| <input type="checkbox"/> Motorizzazione SUNILUS IO
SUNILUS IO Motorization | <input type="checkbox"/> Motorizzazione PERGOLA IO
PERGOLA IO Motorization |
| <input type="checkbox"/> Telecomando
Remote control | <input type="checkbox"/> Monocanale
Single channel |
| | <input type="checkbox"/> Multicanale
Multi-channel |

POSA/INSTALLATION

- | | |
|---|--|
| <input type="checkbox"/> Parete
Wall | <input type="checkbox"/> Soffitto
Ceiling |
|---|--|

2 GUIDE/GUIDES

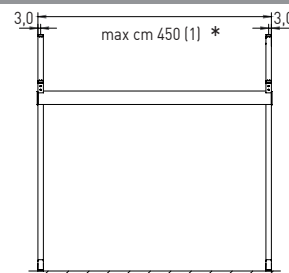

*500 cm fino a 500 cm di sporgenza / 500 cm till 500 cm of projection

DIMENSIONI/DIMENSIONS

- | | | |
|------------------------------------|--------|-------|
| Larghezza
Width | (1) cm | _____ |
| Sporgenza
Projection | (2) cm | _____ |
| Altezza parete
Wall height | (3) cm | _____ |
| Altezza pilastri
Pilar height | (4) cm | _____ |
| Altezza soffitto
Ceiling height | (5) cm | _____ |

3 GUIDE/GUIDES

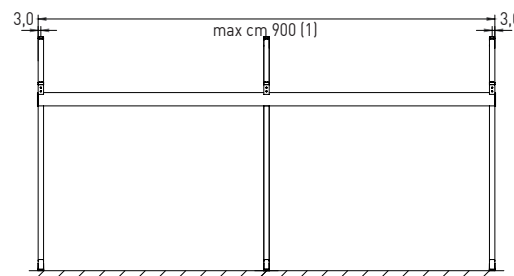

DIMENSIONI/DIMENSIONS

- | | | |
|------------------------------------|--------|-------|
| Larghezza
Width | (1) cm | _____ |
| Sporgenza
Projection | (2) cm | _____ |
| Altezza parete
Wall height | (3) cm | _____ |
| Altezza pilastri
Pilar height | (4) cm | _____ |
| Altezza soffitto
Ceiling height | (5) cm | _____ |

4 GUIDE/GUIDES

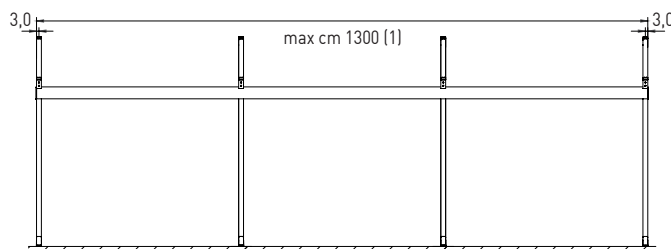

DIMENSIONI/DIMENSIONS

- | | | |
|------------------------------------|--------|-------|
| Larghezza
Width | (1) cm | _____ |
| Sporgenza
Projection | (2) cm | _____ |
| Altezza parete
Wall height | (3) cm | _____ |
| Altezza pilastri
Pilar height | (4) cm | _____ |
| Altezza soffitto
Ceiling height | (5) cm | _____ |

2-3-4 GUIDE/GUIDES

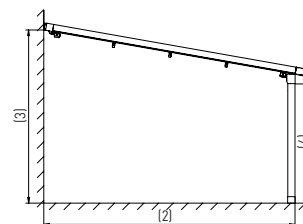

NOTE/NOTES

GENNIUS A100 LINEAR

CLIENTE (timbro) CUSTOMER (stamp)

Quantità/Q.ty _____ Riferimento/Reference _____

Data consegna richiesta/Required delivery date _____

TELO/FABRIC

- | | |
|---|--|
| <input type="checkbox"/> PVC PRECONTRAIKT 602 | oscurante Bianco Opaco
black out matt white |
| <input type="checkbox"/> PVC PRECONTRAIKT 602 | oscurante Avorio Opaco
black out matt ivory |
| <input type="checkbox"/> PVC PRECONTRAIKT 602 | Bianco
White |
| <input type="checkbox"/> PVC PRECONTRAIKT 602 | Avorio
Ivory |
| <input type="checkbox"/> Altro/Other | _____ |

TELO LASCO/SLACK FABRIC

- | |
|--|
| <input type="checkbox"/> Parallelo
Parallel |
| <input type="checkbox"/> Alternato
Alternated |
| <input type="checkbox"/> Asimmetrico
Asymmetrical |

COLORAZIONI/COLOURS

STRUTTURA/STRUCTURE

- | | |
|---|---|
| <input type="checkbox"/> RAL 9010 Bianco
White | <input type="checkbox"/> Nero Inver
Inver black |
| <input type="checkbox"/> RAL 1013 Avorio
Ivory | <input type="checkbox"/> Altro RAL
Other RAL _____ |
| <input type="checkbox"/> RAL 8014 Marrone opaco
Matt brown | |

ANODIZZATO / ANODIZED

- | | | |
|---|---|--|
| <input type="checkbox"/> Acciaio spazzolato lucido
Brushed steel | <input type="checkbox"/> Argento lucido
Brilliant Silver | <input type="checkbox"/> Bronzo chiaro
Light bronze |
| <input type="checkbox"/> Marrone
Brown | <input type="checkbox"/> Testa di moro
Dark brown | |

TRAVERSI/CROSSBAR PROFILES

- | | | |
|-----------------------------------|-----------------------------------|---|
| <input type="checkbox"/> RAL 9010 | <input type="checkbox"/> RAL 1013 | <input type="checkbox"/> Altro
Other _____ |
|-----------------------------------|-----------------------------------|---|

OPTIONAL

- | | | |
|--|---|--|
| <input type="checkbox"/> Guarnizione antipioggia
Drain gasket | <input type="checkbox"/> Grondaia fissa
Fixed gutter | <input type="checkbox"/> Kit Luci
Light Kit |
| <input type="checkbox"/> Tettuccio
Hood | <input type="checkbox"/> Tettuccio
Hood | <input type="checkbox"/> RAL 9010 |
| | | <input type="checkbox"/> RAL 1013 |

MOVIMENTAZIONE/MOVEMENT

*Solo per modello 2 GUIDE/Only for 2-guides-model

- | | | | |
|---|---|---|-------|
| <input type="checkbox"/> Manuale* Asta
Manual*with crank rod | cm _____ | Lato (vista frontale)
Side (frontal side) | _____ |
| <input type="checkbox"/> Motorizzazione KE
KE Motorization | | <input type="checkbox"/> Motorizzazione SOMFY
SOMFY Motorization | |
| <input type="checkbox"/> Motorizzazione SUNILUS IO
SUNILUS IO Motorization | | <input type="checkbox"/> Motorizzazione PERGOLA IO
PERGOLA IO Motorization | |
| Telecomando
Remote control | <input type="checkbox"/> Monocanale
Single channel | <input type="checkbox"/> Multicanale
Multi-channel | |

POSA/INSTALLATION

- | | |
|---|--|
| <input type="checkbox"/> Parete
Wall | <input type="checkbox"/> Soffitto
Ceiling |
|---|--|

2 GUIDE/GUIDES

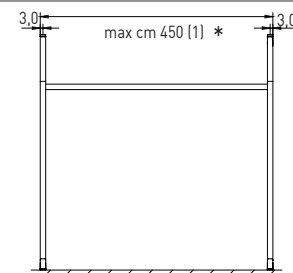

*500 cm fino a 500 cm di sporgenza / 500 cm till 500 cm of projection

DIMENSIONI/DIMENSIONS

Larghezza Width	(1) cm	_____
Sporgenza Projection	(2) cm	_____
Altezza parete Wall height	(3) cm	_____
Altezza pilastri Pilar height	(4) cm	_____
Altezza soffitto Ceiling height	(5) cm	_____

3 GUIDE/GUIDES

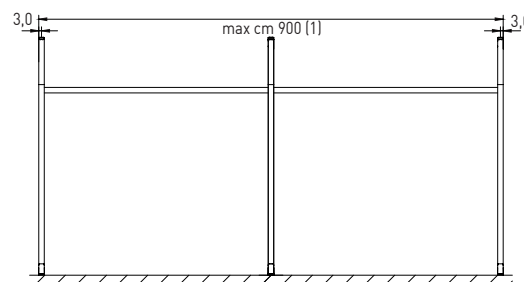

DIMENSIONI/DIMENSIONS

Larghezza Width	(1) cm	_____
Sporgenza Projection	(2) cm	_____
Altezza parete Wall height	(3) cm	_____
Altezza pilastri Pilar height	(4) cm	_____
Altezza soffitto Ceiling height	(5) cm	_____

4 GUIDE/GUIDES

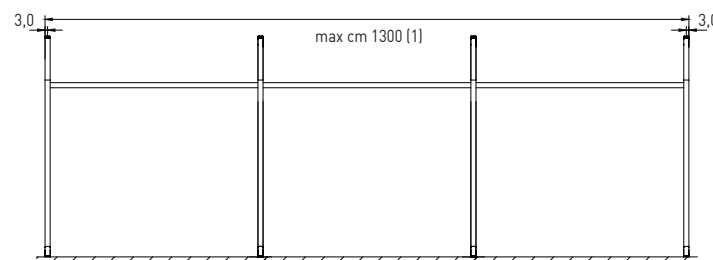

DIMENSIONI/DIMENSIONS

Larghezza Width	(1) cm	_____
Sporgenza Projection	(2) cm	_____
Altezza parete Wall height	(3) cm	_____
Altezza pilastri Pilar height	(4) cm	_____
Altezza soffitto Ceiling height	(5) cm	_____

2-3-4 GUIDE/GUIDES

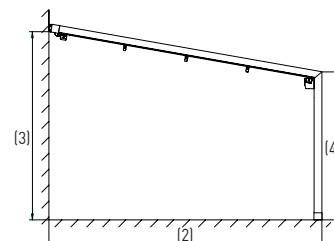

NOTE/NOTES

KE KE PROTEZIONI SOLARI - Inviare questo modulo al fax n. + 39 0421 658840 o via e-mail a info@keitaly.it
Send this order commission by fax to +39 0421 658840 or e-mail to info@keitaly.it

GENNIUS A100 LUX

CLIENTE (timbro) CUSTOMER (stamp)

Quantità/Q.ty _____ Riferimento/Reference _____

Data consegna richiesta/Required delivery date _____

TELO/FABRIC

- PVC PRECONTRAIINT 602 oscurante Bianco Opaco
black out matt white
- PVC PRECONTRAIINT 602 oscurante Avorio Opaco
black out matt ivory
- PVC PRECONTRAIINT 602 Bianco
White
- PVC PRECONTRAIINT 602 Avorio
Ivory
- Altro/Other _____

TELO LASCO/SLACK FABRIC

- Parallelo
Parallel
- Alternato
Alternated
- Asimmetrico
Asymmetrical

COLORAZIONI/COLOURS

STRUTTURA/STRUCTURE

- RAL 9010 Bianco
White
- RAL 1013 Avorio
Ivory
- RAL 8014 Marrone opaco
Matt brown
- Nero Inver
Inver black
- Altro RAL _____
Other RAL

ANODIZZATO / ANODIZED

- Acciaio spazzolato lucido
Brushed steel
- Marrone
Brown
- Argento lucido
Brilliant Silver
- Testa di moro
Dark brown
- Bronzo chiaro
Light bronze

TRAVERSI/CROSSBAR PROFILES

- RAL 9010
- RAL 1013
- Altro _____
Other

OPTIONAL

- Guarnizione anti-pioggia
Drain gasket
- Tettuccio RAL 9010
- Pluviale mobile / Downpipe mobile
- Grondaia fissa / Fixed gutter
- Tettuccio RAL 1013
- Kit Luci
Light Kit

MOVIMENTAZIONE/MOVEMENT

*Solo per modello 2 GUIDE/Only for 2-guides-model

- Manuale* Asta _____ cm
Manual*with crank rod
- Motorizzazione KE
KE Motorization
- Motorizzazione SUNILUS IO
SUNILUS IO Motorization
- Lato (vista frontale) _____
Side (frontal side)
- Motorizzazione SOMFY
SOMFY Motorization
- Motorizzazione PERGOLA IO
PERGOLA IO Motorization
- Telecomando
Remote control
- Monocanale
Single channel
- Multicanale
Multi-channel

POSA/INSTALLATION

- Parete
Wall
- Soffitto
Ceiling

2 GUIDE/GUIDES

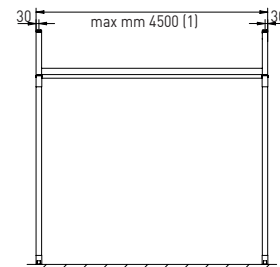

*500 cm fino a 500 cm di sporgenza / 500 cm till 500 cm of projection

DIMENSIONI/DIMENSIONS

- Larghezza Width (1) cm _____
- Sporgenza Projection (2) cm _____
- Altezza parete Wall height (3) cm _____
- Altezza pilastri Pilar height (4) cm _____
- Altezza soffitto Ceiling height (5) cm _____

3 GUIDE/GUIDES

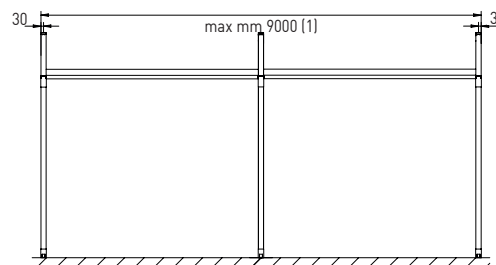

DIMENSIONI/DIMENSIONS

- Larghezza Width (1) cm _____
- Sporgenza Projection (2) cm _____
- Altezza parete Wall height (3) cm _____
- Altezza pilastri Pilar height (4) cm _____
- Altezza soffitto Ceiling height (5) cm _____

4 GUIDE/GUIDES

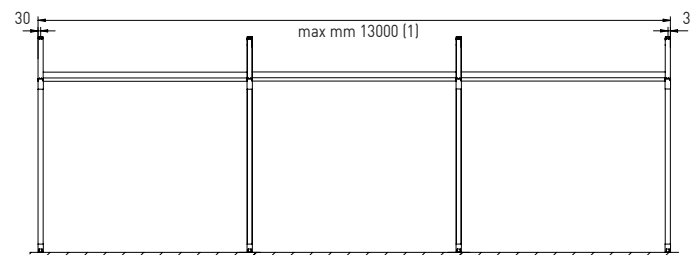

DIMENSIONI/DIMENSIONS

- Larghezza Width (1) cm _____
- Sporgenza Projection (2) cm _____
- Altezza parete Wall height (3) cm _____
- Altezza pilastri Pilar height (4) cm _____
- Altezza soffitto Ceiling height (5) cm _____

2-3-4 GUIDE/GUIDES

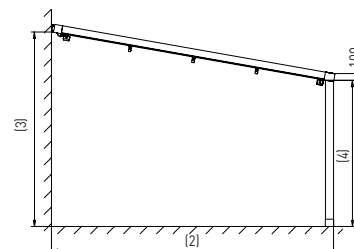

NOTE/NOTES

KE KE PROTEZIONI SOLARI - Inviare questo modulo al fax n. + 39 0421 658840 o via e-mail a info@keitaly.it
Send this order commission by fax to +39 0421 658840 or e-mail to info@keitaly.it

GENNIUS A2 COMPACT

CLIENTE (timbro) CUSTOMER (stamp)

Quantità/Q.ty _____ Riferimento/Reference _____

Data consegna richiesta/Required delivery date _____

TELO/FABRIC

- PVC PRECONTRAIKT 602 oscurante Bianco Opaco
black out matt white
- PVC PRECONTRAIKT 602 oscurante Avorio Opaco
black out matt ivory
- PVC PRECONTRAIKT 602 Bianco
White
- PVC PRECONTRAIKT 602 Avorio
Ivory
- Altro/Other _____

TELO LASCO/SLACK FABRIC

- Parallelo
Parallel
- Alternato
Alternated
- Asimmetrico
Asymmetrical

COLORAZIONI/COLOURS

STRUTTURA/STRUCTURE

- RAL 9010 Bianco
White
- RAL 1013 Avorio
Ivory
- Nero Inver
Inver black
- Altro RAL
Other RAL _____

ANODIZZATO / ANODIZED

- Acciaio spazzolato lucido
Brushed steel
- Marrone
Brown
- Argento lucido
Brilliant Silver
- Testa di moro
Dark brown
- Bronzo chiaro
Light bronze

TRAVERSI/CROSSBAR PROFILES

- RAL 9010
- RAL 1013
- Altro
Other _____

OPTIONAL

- Guarnizione antipioggia
Drain gasket
- Tettuccio RAL 9010
Hood RAL 9010
- Tettuccio RAL 1013
Hood RAL 1013
- Kit Luci
Lights Kit

MOVIMENTAZIONE/MOVEMENT

- Motorizzazione KE
KE Motorization
- Motorizzazione SUNILUS IO
SUNILUS IO Motorization
- Motorizzazione SOMFY
SOMFY Motorization
- Motorizzazione PERGOLA IO
PERGOLA IO Motorization
- Telecomando
Remote control
- Monocanale
Single channel
- Multicanale
Multi-channel

POSA/INSTALLATION

- Parete
Wall
- Soffitto
Ceiling

2 GUIDE/GUIDES

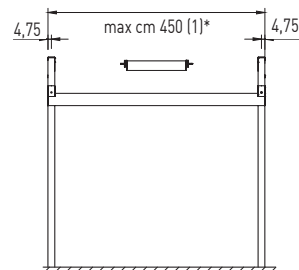

*500 cm fino a 500 cm di sporgenza / 500 cm till 500 cm of projection

DIMENSIONI/DIMENSIONS

Larghezza Width	(1) cm	_____
Sporgenza Projection	(2) cm	_____
Altezza parete Wall height	(3) cm	_____
Altezza pilastri Pilar height	(4) cm	_____
Altezza soffitto Ceiling height	(5) cm	_____

3 GUIDE/GUIDES

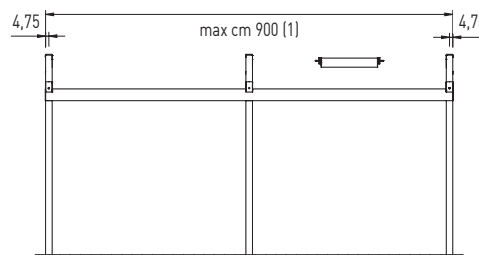

DIMENSIONI/DIMENSIONS

Larghezza Width	(1) cm	_____
Sporgenza Projection	(2) cm	_____
Altezza parete Wall height	(3) cm	_____
Altezza pilastri Pilar height	(4) cm	_____
Altezza soffitto Ceiling height	(5) cm	_____

4 GUIDE/GUIDES

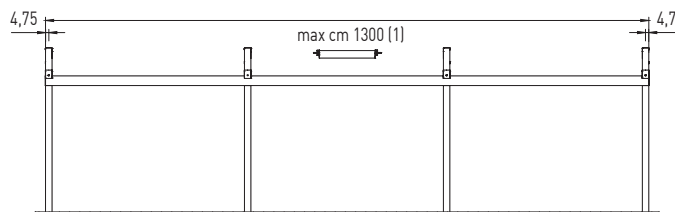

DIMENSIONI/DIMENSIONS

Larghezza Width	(1) cm	_____
Sporgenza Projection	(2) cm	_____
Altezza parete Wall height	(3) cm	_____
Altezza pilastri Pilar height	(4) cm	_____
Altezza soffitto Ceiling height	(5) cm	_____

2-3-4 GUIDE/GUIDES

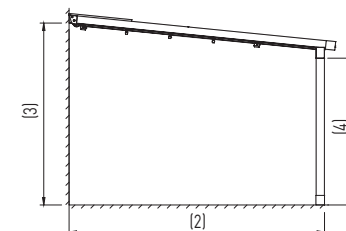

NOTE/NOTES

KE KE PROTEZIONI SOLARI - Inviare questo modulo al fax n. + 39 0421 658840 o via e-mail a info@keitaly.it
Send this order commission by fax to +39 0421 658840 or e-mail to info@keitaly.it

GENNIUS A2 LINEAR

CLIENTE (timbro) CUSTOMER (stamp)

Quantità/Q.ty _____ Riferimento/Reference _____

Data consegna richiesta/Required delivery date _____

TELO/FABRIC

- PVC PRECONTRAIPT 602 oscurante Bianco Opaco
black out matt white
- PVC PRECONTRAIPT 602 oscurante Avorio Opaco
black out matt ivory
- PVC PRECONTRAIPT 602 Bianco
White
- PVC PRECONTRAIPT 602 Avorio
Ivory
- Altro/Other _____

TELO LASCO/SLACK FABRIC

- Parallelo
Parallel
- Alternato
Alternated
- Asimmetrico
Asymmetrical

COLORAZIONI/COLOURS

STRUTTURA/STRUCTURE

- RAL 9010 Bianco
White
- RAL 1013 Avorio
Ivory
- Nero Inver
Inver black
- Altro RAL _____
Other RAL

ANODIZZATO / ANODIZED

- Acciaio spazzolato lucido
Brushed steel
- Marrone
Brown
- Argento lucido
Brilliant Silver
- Testa di moro
Dark brown
- Bronzo chiaro
Light bronze

TRAVERSI/CROSSBAR PROFILES

- RAL 9010
- RAL 1013
- Altro _____
Other

OPTIONAL

- Guarnizione anti-pioggia
Drain gasket
- Tettuccio
Hood
- Grondaia fissa
Fixed gutter
- Tettuccio
Hood
- Pluviale mobile
Downpipe mobile
- Kit Luci
Light Kit

MOVIMENTAZIONE/MOVEMENT

- Motorizzazione KE
KE Motorization
- Motorizzazione SUNILUS IO
SUNILUS IO Motorization
- Motorizzazione SOMFY
SOMFY Motorization
- Motorizzazione PERGOLA IO
PERGOLA IO Motorization
- Telecomando
Remote control
- Monocanale
Single channel
- Multicanale
Multi-channel

POSA/INSTALLATION

- Parete
Wall
- Soffitto
Ceiling

2 GUIDE/GUIDES

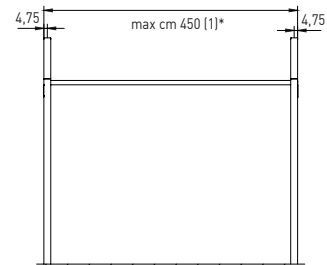

*500 cm fino a 500 cm di sporgenza / 500 cm till 500 cm of projection

DIMENSIONI/DIMENSIONS

Larghezza Width	(1) cm	_____
Sporgenza Projection	(2) cm	_____
Altezza parete Wall height	(3) cm	_____
Altezza pilastri Pilar height	(4) cm	_____
Altezza soffitto Ceiling height	(5) cm	_____

3 GUIDE/GUIDES

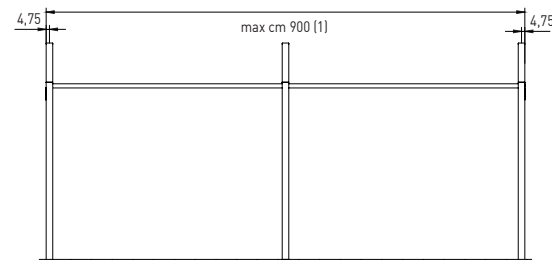

DIMENSIONI/DIMENSIONS

Larghezza Width	(1) cm	_____
Sporgenza Projection	(2) cm	_____
Altezza parete Wall height	(3) cm	_____
Altezza pilastri Pilar height	(4) cm	_____
Altezza soffitto Ceiling height	(5) cm	_____

4 GUIDE/GUIDES

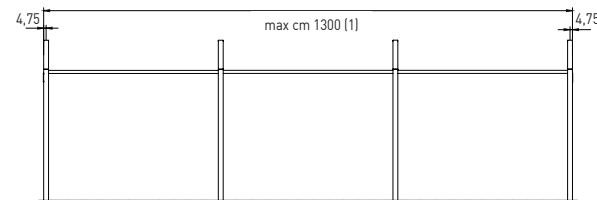

DIMENSIONI/DIMENSIONS

Larghezza Width	(1) cm	_____
Sporgenza Projection	(2) cm	_____
Altezza parete Wall height	(3) cm	_____
Altezza pilastri Pilar height	(4) cm	_____
Altezza soffitto Ceiling height	(5) cm	_____

2-3-4 GUIDE/GUIDES

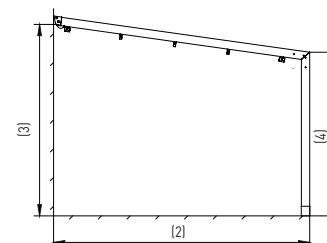

NOTE/NOTES

KE KE PROTEZIONI SOLARI - Inviare questo modulo al fax n. +39 0421 658840 o via e-mail a info@keitaly.it
Send this order commission by fax to +39 0421 658840 or e-mail to info@keitaly.it

CLIENTE (timbro) CUSTOMER (stamp)

Quantità/Q.ty _____ Riferimento/Reference _____

Data consegna richiesta/Required delivery date _____

TELO/FABRIC

- | | |
|---|--|
| <input type="checkbox"/> PVC PRECONTRAIKT 602 | oscurante Bianco Opaco
black out matt white |
| <input type="checkbox"/> PVC PRECONTRAIKT 602 | oscurante Avorio Opaco
black out matt ivory |
| <input type="checkbox"/> PVC PRECONTRAIKT 602 | Bianco
White |
| <input type="checkbox"/> PVC PRECONTRAIKT 602 | Avorio
Ivory |
| <input type="checkbox"/> Altro/Other | _____ |

TELO LASCO/SLACK FABRIC

- | |
|--|
| <input type="checkbox"/> Parallelo
Parallel |
| <input type="checkbox"/> Alternato
Alternated |
| <input type="checkbox"/> Asimmetrico
Asymmetrical |

COLORAZIONI/COLOURS
STRUTTURA/STRUCTURE

- | | | |
|--|---|---|
| <input type="checkbox"/> RAL 9010 Bianco lucido
White | <input type="checkbox"/> RAL 8014 Marrone opaco
Matt brown | <input type="checkbox"/> Bianco antico
Ancient white |
| <input type="checkbox"/> RAL 9010 Bianco opaco
Matt white | <input type="checkbox"/> RAL 8017 Marrone
Brown | <input type="checkbox"/> Grigio ruvido
Rough grey |
| <input type="checkbox"/> RAL 1013 Avorio lucido
Ivory | <input type="checkbox"/> RAL 6005 Verde
Green | <input type="checkbox"/> Marrone antico
Ancient brown |
| <input type="checkbox"/> RAL 1013 Avorio opaco
Matt ivory | <input type="checkbox"/> RAL 3003 Rosso
Red | <input type="checkbox"/> Nero Inver
Inver black |
| <input type="checkbox"/> RAL 9006 Grigio
Grey | <input type="checkbox"/> RAL fuori standard
Non standard RAL | <input type="checkbox"/> Verde marmo antico
Ancient green marble |
| | | <input type="checkbox"/> Altro
Other |

ANODIZZATO / ANODIZED

- | | | |
|---|---|--|
| <input type="checkbox"/> Acciaio spazzolato lucido
Brushed steel | <input type="checkbox"/> Argento lucido
Brilliant Silver | <input type="checkbox"/> Bronzo chiaro
Light bronze |
| <input type="checkbox"/> Marrone
Brown | <input type="checkbox"/> Testa di moro
Dark brown | |

TRAVERSI/CROSSBAR PROFILES

- | | |
|--|--|
| <input type="checkbox"/> RAL 9010 Bianco lucido
White | <input type="checkbox"/> Altro
Other colour |
| <input type="checkbox"/> RAL 1013 Avorio lucido
Ivory | |

OPTIONAL

- | | | | |
|--|---|---|---|
| <input type="checkbox"/> Guarnizione antipioggia
Drain gasket | <input type="checkbox"/> Tettuccio RAL 9010
Hood | <input type="checkbox"/> Tettuccio RAL 1013
Hood | <input type="checkbox"/> Kit Luci
Lights Kit |
|--|---|---|---|

MOVIMENTAZIONE/MOVEMENT

- | | |
|---|---|
| <input type="checkbox"/> Motorizzazione KE
KE Motorization | <input type="checkbox"/> Motorizzazione SOMFY
SOMFY Motorization |
| <input type="checkbox"/> Motorizzazione SUNILUS IO
SUNILUS IO Motorization | <input type="checkbox"/> Motorizzazione PERGOLA IO
PERGOLA IO Motorization |
| Telecomando
Remote control | <input type="checkbox"/> Monocanale
Single channel |
| | <input type="checkbox"/> Multicanale
Multi-channel |

POSA/INSTALLATION

- | | |
|---|--|
| <input type="checkbox"/> Parete
Wall | <input type="checkbox"/> Soffitto
Ceiling |
|---|--|

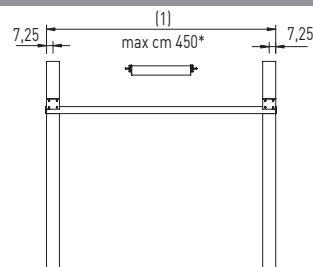
2 GUIDE/GUIDES

*500 cm fino a 500 cm di sporgenza / 500 cm till 500 cm of projection

DIMENSIONI/DIMENSIONS

Larghezza Width	(1) cm	_____
Sporgenza Projection	(2) cm	_____
Altezza parete Wall height	(3) cm	_____
Altezza pilastri Pilar height	(4) cm	_____
Altezza soffitto Ceiling height	(5) cm	_____

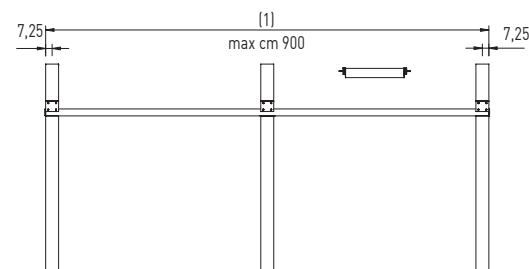
3 GUIDE/GUIDES

DIMENSIONI/DIMENSIONS

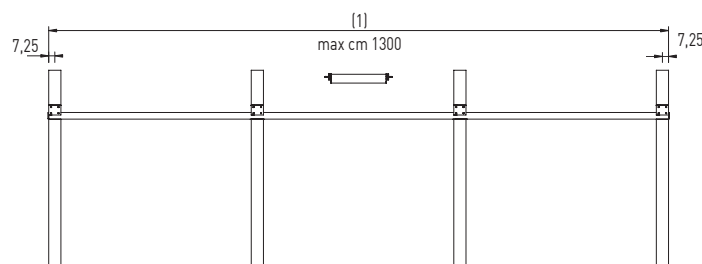
Larghezza Width	(1) cm	_____
Sporgenza Projection	(2) cm	_____
Altezza parete Wall height	(3) cm	_____
Altezza pilastri Pilar height	(4) cm	_____
Altezza soffitto Ceiling height	(5) cm	_____

4 GUIDE/GUIDES

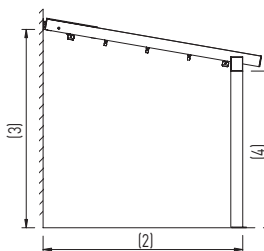
DIMENSIONI/DIMENSIONS

Larghezza Width	(1) cm	_____
Sporgenza Projection	(2) cm	_____
Altezza parete Wall height	(3) cm	_____
Altezza pilastri Pilar height	(4) cm	_____
Altezza soffitto Ceiling height	(5) cm	_____

2-3-4 GUIDE/GUIDES

NOTE/NOTES

Quantità/Q.ty _____ Riferimento/Reference _____

Data consegna richiesta/Required delivery date _____

TELO/FABRIC

- PVC PRECONTRAIKT 602 oscurante Bianco Opaco
black out matt white
- PVC PRECONTRAIKT 602 oscurante Avorio Opaco
black out matt ivory
- PVC PRECONTRAIKT 602 Bianco
White
- PVC PRECONTRAIKT 602 Avorio
Ivory
- Altro/Other _____

TELO LASCO/SLACK FABRIC

- Parallelo
Parallel
- Alternato
Alternated
- Asimmetrico
Asymmetrical

**COLORAZIONI/COLOURS
STRUTTURA/STRUCTURE**

- | | | |
|--|---|---|
| <input type="checkbox"/> RAL 9010 Bianco lucido
White | <input type="checkbox"/> RAL 8014 Marrone opaco
Matt brown | <input type="checkbox"/> Bianco antico
Ancient white |
| <input type="checkbox"/> RAL 9010 Bianco opaco
Matt white | <input type="checkbox"/> RAL 8017 Marrone
Brown | <input type="checkbox"/> Grigio ruvido
Rough grey |
| <input type="checkbox"/> RAL 1013 Avorio lucido
Ivory | <input type="checkbox"/> RAL 6005 Verde
Green | <input type="checkbox"/> Marrone antico
Ancient brown |
| <input type="checkbox"/> RAL 1013 Avorio opaco
Matt ivory | <input type="checkbox"/> RAL 3003 Rosso
Red | <input type="checkbox"/> Nero Inver
Inver black |
| <input type="checkbox"/> RAL 9006 Grigio
Grey | <input type="checkbox"/> RAL fuori standard _____
Non standard RAL | <input type="checkbox"/> Verde marmo antico
Ancient green marble |
| | | <input type="checkbox"/> Altro _____
Other |

ANODIZZATO / ANODIZED

- | | | |
|---|---|--|
| <input type="checkbox"/> Acciaio spazzolato lucido
Brushed steel | <input type="checkbox"/> Argento lucido
Brilliant Silver | <input type="checkbox"/> Bronzo chiaro
Light bronze |
| <input type="checkbox"/> Marrone
Brown | <input type="checkbox"/> Testa di moro
Dark brown | |

TRAVERSI/CROSSBAR PROFILES

- RAL 9010 Bianco lucido
White
- RAL 1013 Avorio lucido
Ivory
- Altro _____
Other colour

OPTIONAL

- | | | |
|--|---|---|
| <input type="checkbox"/> Guarnizione antipioggia
Drain gasket | <input type="checkbox"/> Grondaia fissa
Fixed gutter | <input type="checkbox"/> Pluviale mobile
Downpipe mobile |
| <input type="checkbox"/> Tettuccio
Hood | <input type="checkbox"/> Tettuccio
Hood | <input type="checkbox"/> Kit Luci
Light Kit |

MOVIMENTAZIONE/MOVEMENT

- | | |
|---|---|
| <input type="checkbox"/> Motorizzazione KE
KE Motorization | <input type="checkbox"/> Motorizzazione SOMFY
SOMFY Motorization |
| <input type="checkbox"/> Motorizzazione SUNILUS IO
SUNILUS IO Motorization | <input type="checkbox"/> Motorizzazione PERGOLA IO
PERGOLA IO Motorization |
| Telecomando
Remote control | <input type="checkbox"/> Monocanale
Single channel |
| | <input type="checkbox"/> Multicanale
Multi-channel |

POSA/INSTALLATION

- Parete
Wall
- Soffitto
Ceiling

2 GUIDE/GUIDES

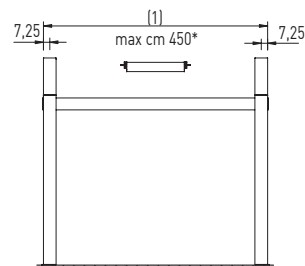

*500 cm fino a 500 cm di sporgenza / 500 cm till 500 cm of projection

DIMENSIONI/DIMENSIONS

- Larghezza (1) cm _____
Width
- Sporgenza (2) cm _____
Projection
- Altezza parete (3) cm _____
Wall height
- Altezza pilastri (4) cm _____
Pillar height

3 GUIDE/GUIDES

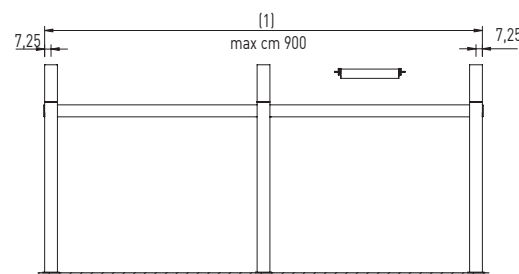

DIMENSIONI/DIMENSIONS

- Larghezza (1) cm _____
Width
- Sporgenza (2) cm _____
Projection
- Altezza parete (3) cm _____
Wall height
- Altezza pilastri (4) cm _____
Pillar height

4 GUIDE/GUIDES

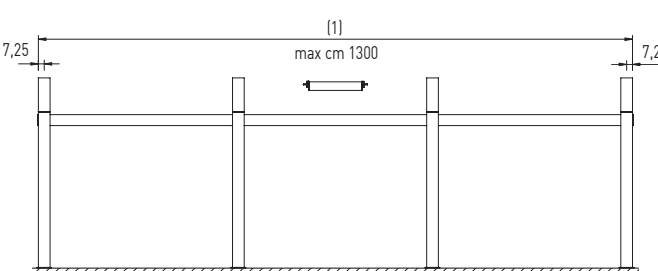

DIMENSIONI/DIMENSIONS

- Larghezza (1) cm _____
Width
- Sporgenza (2) cm _____
Projection
- Altezza parete (3) cm _____
Wall height
- Altezza pilastri (4) cm _____
Pillar height

2-3-4 GUIDE/GUIDES

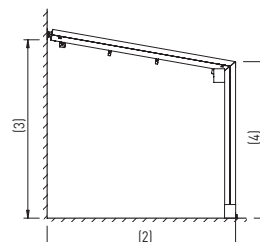

NOTE/NOTES

CLIENTE (timbro) CUSTOMER (stamp)

Quantità/Q.ty _____ Riferimento/Reference _____

Data consegna richiesta/Required delivery date _____

COLORAZIONI/COLOURS

STRUTTURA/STRUCTURE

RAL 9010 Bianco White Altro RAL Other RAL _____

TELO SUPERIORE/UPPER FABRIC

Soltis 86 cod. _____

S-LIGHT

Tessuto Fabric Cod. _____

TENDE PERIMETRALI/DROP AWNING

Tessuto Fabric Cod. _____ Q.tà/Q.ty _____

OPTIONAL

Piastra per fissaggio su terreno Plate for fixing on the ground Q.tà/Q.ty _____

Piastra per fissaggio su sabbia Plate for fixing on sand Q.tà/Q.ty _____

4 MONTANTI/PILLARS

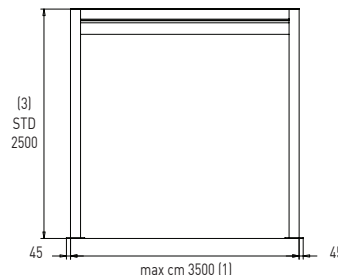

DIMENSIONI/DIMENSIONS

Larghezza Width (1) cm _____

Sporgenza Projection (2) cm _____

Altezza pilastri Pilar height (3) cm _____

6 MONTANTI/PILLARS

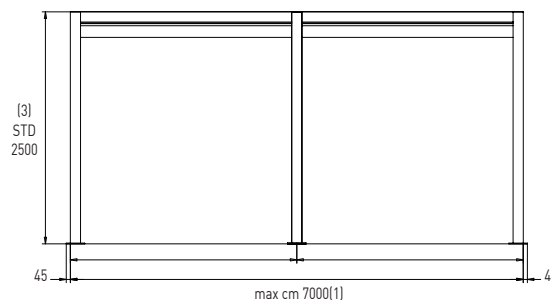

DIMENSIONI/DIMENSIONS

Larghezza Width (1) cm _____

Sporgenza Projection (2) cm _____

Altezza pilastri Pilar height (3) cm _____

4-6 MONTANTI/PILLARS

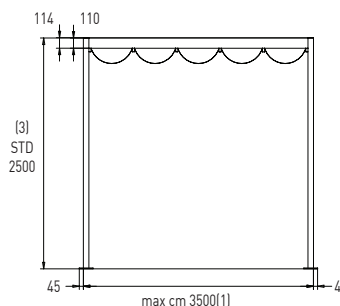

NOTE/NOTES

CLIENTE (timbro) CUSTOMER (stamp)

Quantità/Q.ty _____ Riferimento/Reference _____

Data consegna richiesta/Required delivery date _____

TELO/FABRIC

- PVC PRECONSTRAINT 602 oscurante Bianco Opaco
 black out matt white
 PVC PRECONSTRAINT 602 oscurante Avorio Opaco
 black out matt ivory
 PVC PRECONSTRAINT 602 Bianco
 White
 PVC PRECONSTRAINT 602 Avorio
 Ivory
 Altro/Other _____

COLORAZIONI/COLOURS
STRUTTURA/STRUCTURE

- RAL 9010 Bianco
 White Nero Inver
 Inver black
 Altro RAL _____
 Other RAL _____

TRAVERSI/CROSSBAR PROFILES

- RAL 9010 RAL 1013 Altro
 Other _____

OPTIONAL

- Guarnizione antipioggia Tettuccio RAL 9010 Tettuccio RAL 1013
 Drain gasket Hood Hood
 Gocciolatoio aggiuntivo Kit Luci
 Additional drip tray Light Kit

MOVIMENTAZIONE/MOVEMENT

- Motorizzazione KE Motorizzazione SOMFY
 KE Motorization SOMFY Motorization
 Motorizzazione SUNILUS IO Motorizzazione PERGOLA IO
 SUNILUS IO Motorization PERGOLA IO Motorization

- Telecomando Monocanale Multicanale
 Remote control Single channel Multi-channel

4 MONTANTI/PILLARS

DIMENSIONI/DIMENSIONS

- Larghezza (1) cm _____
 Width
 Sporgenza (2) cm _____
 Projection
 Altezza pilastri (3) cm _____
 Pilar height
 Lato inclinazione telo (4) cm _____
 Inclination fabric side

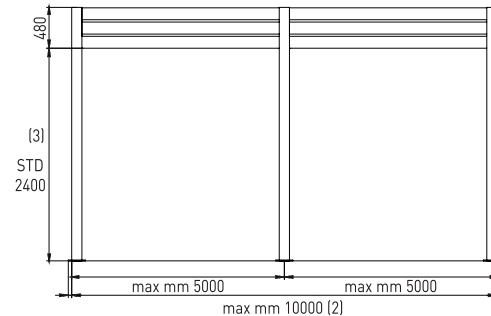
6 MONTANTI/PILLARS

DIMENSIONI/DIMENSIONS

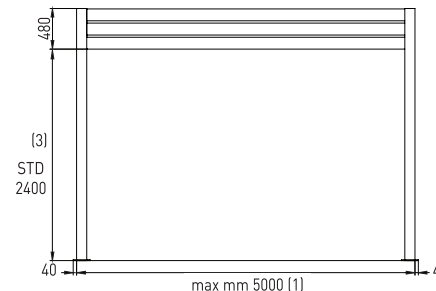
- Larghezza (1) cm _____
 Width
 Sporgenza (2) cm _____
 Projection
 Altezza pilastri (3) cm _____
 Pilar height

4-6 MONTANTI/PILLARS

NOTE/NOTES

CLIENTE (timbro) CUSTOMER (stamp)

Quantità/Q.ty _____ Riferimento/Reference _____

Data consegna richiesta/Required delivery date _____

ORIENTAMENTO TRAVERSI PORTATESSUTO/FABRIC CARRYING ORIENTATION

-
- Paralleli alla parete
-
- Parallel to the wall
-
- Perpendicolari alla parete
-
- Perpendicular to the wall

TELO/FABRIC

-
- PVC PRECONTRAIINT 602 oscurante Bianco Opaco
-
- black out matt white
-
- PVC PRECONTRAIINT 602 oscurante Avorio Opaco
-
- black out matt ivory
-
- PVC PRECONTRAIINT 602 Bianco
-
- White
-
- PVC PRECONTRAIINT 602 Avorio
-
- Ivory
-
- Altro/Other _____

COLORAZIONI/COLOURS
STRUTTURA/STRUCTURE

-
- RAL 9010 Bianco
-
- White
-
- Nero Inver
-
- Inver black
-
- Altro RAL
-
- Other RAL _____

TRAVERSI/CROSSBAR PROFILES

-
- RAL 9010
-
- RAL 1013
-
- Altro
-
- Other _____

OPTIONAL

-
- Guarnizione antipioggia
-
- Drain gasket
-
- Tettuccio RAL 9010
-
- Hood
-
- Tettuccio RAL 1013
-
- Hood
-
- Gocciolatoio aggiuntivo
-
- Additional drip tray
-
- Kit Luci
-
- Light Kit

MOVIMENTAZIONE/MOVEMENT

-
- Motorizzazione KE
-
- KE Motorization
-
- Motorizzazione SOMFY
-
- SOMFY Motorization
-
- Motorizzazione SUNILUS IO
-
- SUNILUS IO Motorization
-
- Motorizzazione PERGOLA IO
-
- PERGOLA IO Motorization

-
- Telecomando
-
- Remote control
-
- Monocanale
-
- Single channel
-
- Multicanale
-
- Multi-channel

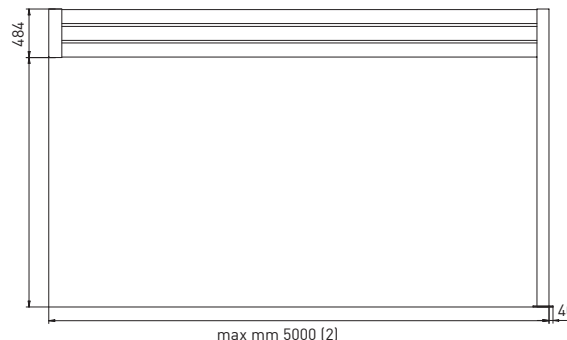
2 MONTANTI/PILLARS

DIMENSIONI/DIMENSIONS

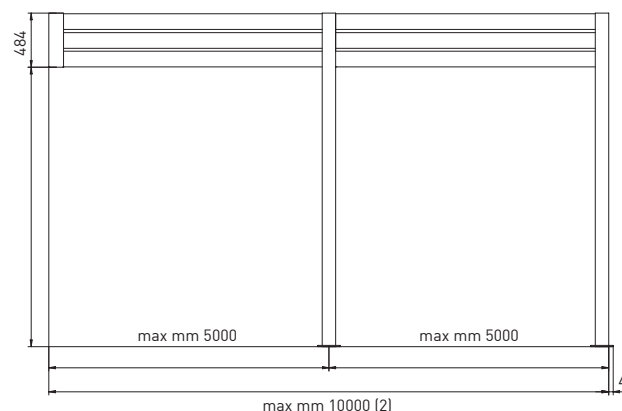
- Larghezza
-
- Width (1) cm _____
 Sporgenza
-
- Projection (2) cm _____
 Altezza pilastri
-
- Pilar height (3) cm _____
 Lato inclinazione telo
-
- Inclination fabric side (4) cm _____

4 MONTANTI/PILLARS

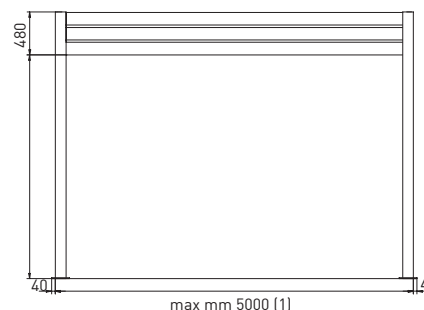
DIMENSIONI/DIMENSIONS

- Larghezza
-
- Width (1) cm _____
 Sporgenza
-
- Projection (2) cm _____
 Altezza pilastri
-
- Pilar height (3) cm _____

2-4 MONTANTI/PILLARS

NOTE/NOTES

GENNIUS ISOLA 2

CLIENTE (timbro) CUSTOMER (stamp)

Quantità/Q.ty _____ Riferimento/Reference _____

Data consegna richiesta/Required delivery date _____

TELO/FABRIC

- PVC PRECONSTRAINT 602 oscurante Bianco Opaco
black out matt white
- PVC PRECONSTRAINT 602 oscurante Avorio Opaco
black out matt ivory
- PVC PRECONSTRAINT 602 Bianco
White
- PVC PRECONSTRAINT 602 Avorio
Ivory
- Altro/Other _____

COLORAZIONI/COLOURS

STRUTTURA/STRUCTURE

- RAL 9010 Bianco
White
- Nero Inver
Inver black
- Altro RAL
Other RAL _____

TRAVERSI/CROSSBAR PROFILES

- RAL 9010
- RAL 1013
- Altro
Other _____

MOVIMENTAZIONE/MOVEMENT

- Motorizzazione KE
KE Motorization
- Motorizzazione SOMFY
SOMFY Motorization
- Motorizzazione SUNILUS IO
SUNILUS IO Motorization
- Motorizzazione PERGOLA IO
PERGOLA IO Motorization

- Telecomando Remote control
- Monocanale
Single channel
- Multicanale
Multi-channel

4 MONTANTI/PILLARS

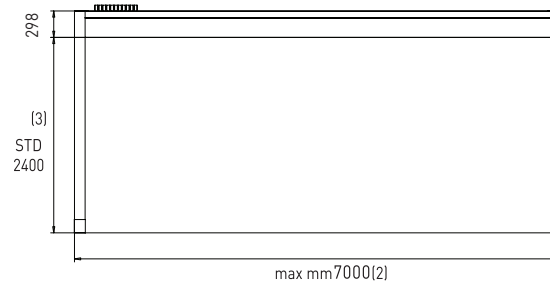

DIMENSIONI/DIMENSIONS

- Larghezza Width (1) cm _____
- Sporgenza Projection (2) cm _____
- Altezza pilastri Pilar height (3) cm _____

6 MONTANTI/PILLARS

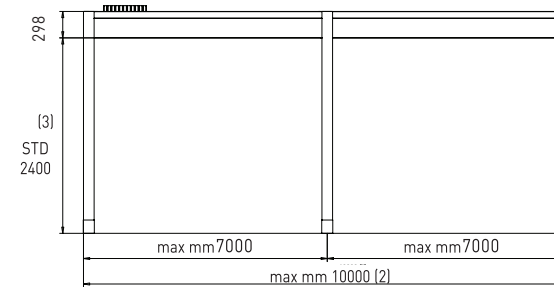

DIMENSIONI/DIMENSIONS

- Larghezza Width (1) cm _____
- Sporgenza Projection (2) cm _____
- Altezza pilastri Pilar height (3) cm _____

4-6 MONTANTI/PILLARS

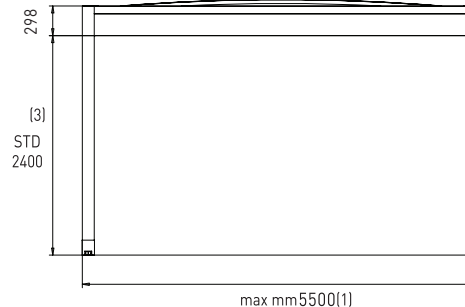

NOTE/NOTES

GENNIUS ISOLA 2 A

CLIENTE (timbro) CUSTOMER (stamp)

Quantità/Q.ty _____ Riferimento/Reference _____

Data consegna richiesta/Required delivery date _____

TELO/FABRIC

- PVC PRECONSTRAINT 602 oscurante Bianco Opaco
black out matt white
- PVC PRECONSTRAINT 602 oscurante Avorio Opaco
black out matt ivory
- PVC PRECONSTRAINT 602 Bianco
White
- PVC PRECONSTRAINT 602 Avorio
Ivory
- Altro/Other _____

COLORAZIONI/COLOURS

STRUTTURA/STRUCTURE

- RAL 9010 Bianco
White
- Nero Inver
Inver black
- Altro RAL
Other RAL _____

TRAVERSI/CROSSBAR PROFILES

- RAL 9010
- RAL 1013
- Altro
Other _____

MOVIMENTAZIONE/MOVEMENT

- Motorizzazione KE
KE Motorization
- Motorizzazione SOMFY
SOMFY Motorization
- Motorizzazione SUNILUS IO
SUNILUS IO Motorization
- Motorizzazione PERGOLA IO
PERGOLA IO Motorization
- Telecomando Remote control
- Monocanale
Single channel
- Multicanale
Multi-channel

2 MONTANTI/PILLARS

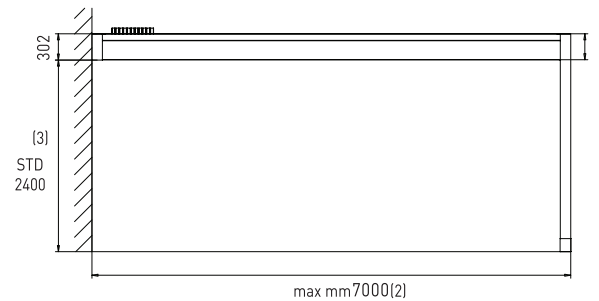

DIMENSIONI/DIMENSIONS

- Larghezza Width (1) cm _____
- Sporgenza Projection (2) cm _____
- Altezza pilastri Pilar height (3) cm _____

4 MONTANTI/PILLARS

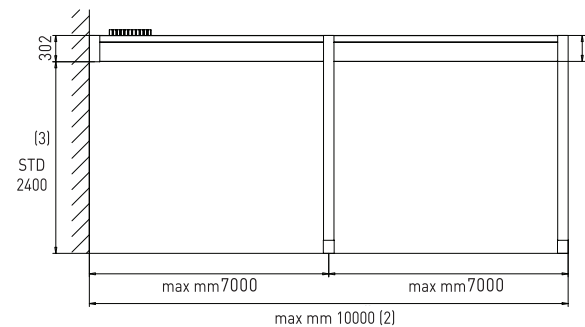

DIMENSIONI/DIMENSIONS

- Larghezza Width (1) cm _____
- Sporgenza Projection (2) cm _____
- Altezza pilastri Pilar height (3) cm _____

2-4 MONTANTI/PILLARS

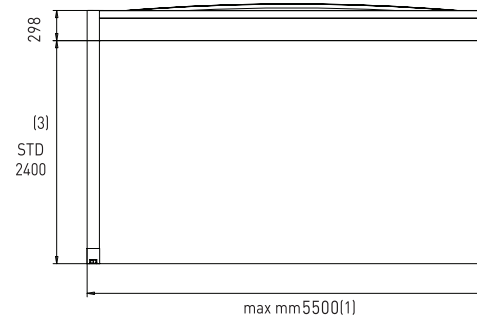

NOTE/NOTES

GENNIUS A2 Compact autoportante singola

CLIENTE (timbro) CUSTOMER (stamp)

Quantità/Q.ty

Riferimento/Reference

Data consegna richiesta/Required delivery date

TELO/FABRIC

- PVC PRECONTRAI 602 oscurante Bianco Opaco
black out matt white
- PVC PRECONTRAI 602 oscurante Avorio Opaco
black out matt ivory
- PVC PRECONTRAI 602 Bianco
White
- PVC PRECONTRAI 602 Avorio
Ivory
- Altro/Other _____

TELO LASCO/SLACK FABRIC

- Parallelo
Parallel
- Alternato
Alternated
- Asimmetrico
Asymmetrical

COLORAZIONI/COLOURS

STRUTTURA/STRUCTURE

- RAL 9010 Bianco
White
- RAL 1013 Avorio
Ivory
- Nero Inver
Inver black
- Altro RAL
Other RAL _____

ANODIZZATO / ANODIZED

- Acciaio spazzolato lucido
Brushed steel
- Marrone
Brown
- Argento lucido
Brilliant Silver
- Testa di moro
Dark brown
- Bronzo chiaro
Light bronze

TRAVERSI/CROSSBAR PROFILES

- RAL 9010
- RAL 1013
- Altro
Other _____

OPTIONAL

- Guarnizione antipioggia
Drain gasket
- Tettuccio
Hood
- Tettuccio
Hood
- Kit Luci
Lights Kit

MOVIMENTAZIONE/MOVEMENT

- Motorizzazione KE
KE Motorization
- Motorizzazione SUNILUS IO
SUNILUS IO Motorization
- Motorizzazione SOMFY
SOMFY Motorization
- Motorizzazione PERGOLA IO
PERGOLA IO Motorization

Telecomando
Remote control

Monocanale
Single channel

Multicanale
Multi-channel

2 GUIDE/GUIDES

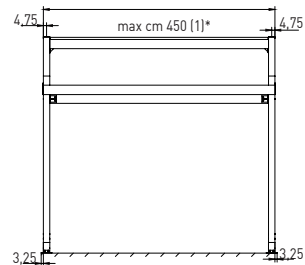

*500 cm fino a 500 cm di sporgenza / 500 cm till 500 cm of projection

DIMENSIONI/DIMENSIONS

- Larghezza
Width (1) cm _____
- Sporgenza
Projection (2) cm _____
- Altezza parete
Wall height (3) cm _____
- Altezza pilastri
Pilar height (4) cm _____

3 GUIDE/GUIDES

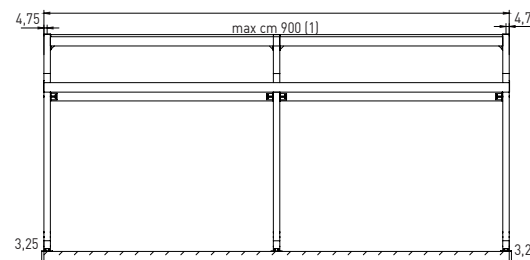

DIMENSIONI/DIMENSIONS

- Larghezza
Width (1) cm _____
- Sporgenza
Projection (2) cm _____
- Altezza parete
Wall height (3) cm _____
- Altezza pilastri
Pilar height (4) cm _____

4 GUIDE/GUIDES

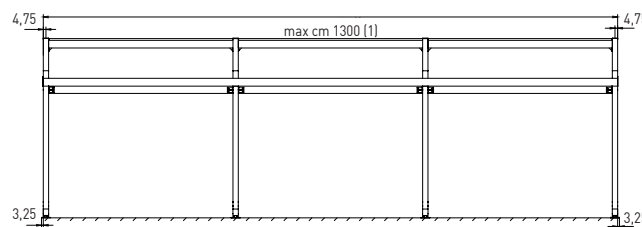

DIMENSIONI/DIMENSIONS

- Larghezza
Width (1) cm _____
- Sporgenza
Projection (2) cm _____
- Altezza parete
Wall height (3) cm _____
- Altezza pilastri
Pilar height (4) cm _____

2-3-4 GUIDE/GUIDES

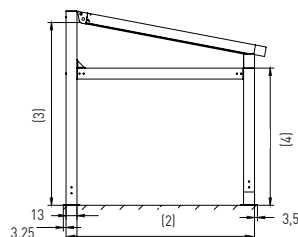

NOTE/NOTES

KE KE PROTEZIONI SOLARI - Inviare questo modulo al fax n. + 39 0421 658840 o via e-mail a info@keitaly.it
Send this order commission by fax to +39 0421 658840 or e-mail to info@keitaly.it

GENNIUS A4 autoportante singola

CLIENTE (timbro) CUSTOMER (stamp)

Quantità/Q.ty _____ Riferimento/Reference _____

Data consegna richiesta/Required delivery date _____

TELO/FABRIC

- PVC PRECONSTRAINT 602 oscurante Bianco Opaco
black out matt white
- PVC PRECONSTRAINT 602 oscurante Avorio Opaco
black out matt ivory
- PVC PRECONSTRAINT 602 Bianco
White
- PVC PRECONSTRAINT 602 Avorio
Ivory
- Altro/Other _____

TELO LASCO/SLACK FABRIC

- Parallelo
Parallel
- Alternato
Alternated
- Asimmetrico
Asymmetrical

COLORAZIONI/COLOURS

STRUTTURA/STRUCTURE

- | | | |
|--|---|---|
| <input type="checkbox"/> RAL 9010 Bianco lucido
White | <input type="checkbox"/> RAL 8014 Marrone opaco
Matt brown | <input type="checkbox"/> Bianco antico
Ancient white |
| <input type="checkbox"/> RAL 9010 Bianco opaco
Matt white | <input type="checkbox"/> RAL 8017 Marrone
Brown | <input type="checkbox"/> Grigio ruvido
Rough grey |
| <input type="checkbox"/> RAL 1013 Avorio lucido
Ivory | <input type="checkbox"/> RAL 6005 Verde
Green | <input type="checkbox"/> Marrone antico
Ancient brown |
| <input type="checkbox"/> RAL 1013 Avorio opaco
Matt ivory | <input type="checkbox"/> RAL 3003 Rosso
Red | <input type="checkbox"/> Nero Inver
Inver black |
| <input type="checkbox"/> RAL 9006 Grigio
Grey | <input type="checkbox"/> RAL fuori standard
Non standard RAL | <input type="checkbox"/> Verde marmo antico
Ancient green marble |
| | | <input type="checkbox"/> Altro
Other |

ANODIZZATO / ANODIZED

- | | | |
|---|---|--|
| <input type="checkbox"/> Acciaio spazzolato lucido
Brushed steel | <input type="checkbox"/> Argento lucido
Brilliant Silver | <input type="checkbox"/> Bronzo chiaro
Light bronze |
| <input type="checkbox"/> Marrone
Brown | <input type="checkbox"/> Testa di moro
Dark brown | |

TRAVERSI/CROSSBAR PROFILES

- | | |
|--|--|
| <input type="checkbox"/> RAL 9010 Bianco lucido
White | <input type="checkbox"/> Altro
Other colour _____ |
| <input type="checkbox"/> RAL 1013 Avorio lucido
Ivory | |

OPTIONAL

- | | | |
|--|---|---|
| <input type="checkbox"/> Guarnizione antipioviggia
Drain gasket | <input type="checkbox"/> Grondaia fissa
Fixed gutter | <input type="checkbox"/> Pluviale mobile
Downpipe mobile |
| <input type="checkbox"/> Tettuccio
Hood RAL 9010 | <input type="checkbox"/> Tettuccio
Hood RAL 1013 | <input type="checkbox"/> Kit Luci
Lights Kit |

MOVIMENTAZIONE/MOVEMENT

- | | |
|---|---|
| <input type="checkbox"/> Motorizzazione KE
KE Motorization | <input type="checkbox"/> Motorizzazione SOMFY
SOMFY Motorization |
| <input type="checkbox"/> Motorizzazione SUNILUS IO
SUNILUS IO Motorization | <input type="checkbox"/> Motorizzazione PERGOLA IO
PERGOLA IO Motorization |

- | | | |
|--|---|---|
| <input type="checkbox"/> Telecomando
Remote control | <input type="checkbox"/> Monocanale
Single channel | <input type="checkbox"/> Multicanale
Multi-channel |
|--|---|---|

2 GUIDE/GUIDES

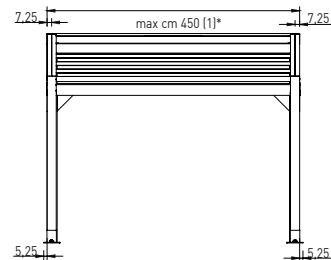

*500 cm fino a 500 cm di sporgenza / 500 cm till 500 cm of projection

DIMENSIONI/DIMENSIONS

- Larghezza (1) cm _____
Width
- Sporgenza (2) cm _____
Projection
- Altezza parete (3) cm _____
Wall height
- Altezza pilastri (4) cm _____
Pilar height

3 GUIDE/GUIDES

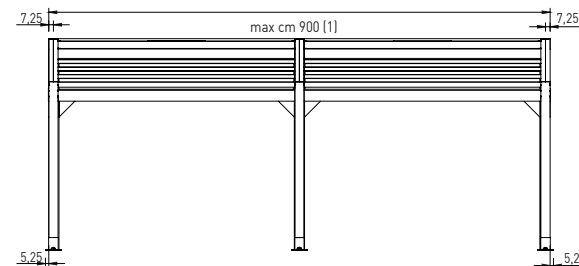

DIMENSIONI/DIMENSIONS

- Larghezza (1) cm _____
Width
- Sporgenza (2) cm _____
Projection
- Altezza parete (3) cm _____
Wall height
- Altezza pilastri (4) cm _____
Pilar height

4 GUIDE/GUIDES

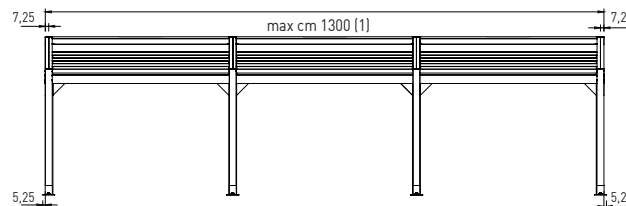

DIMENSIONI/DIMENSIONS

- Larghezza (1) cm _____
Width
- Sporgenza (2) cm _____
Projection
- Altezza parete (3) cm _____
Wall height
- Altezza pilastri (4) cm _____
Pilar height

2-3-4 GUIDE/GUIDES

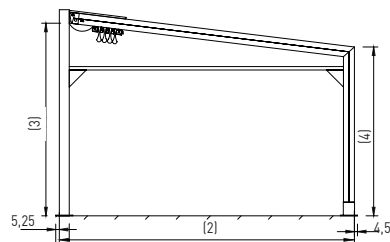

NOTE/NOTES

KE KE PROTEZIONI SOLARI - Inviare questo modulo al fax n. + 39 0421 658840 o via e-mail a info@keitaly.it
Send this order commission by fax to +39 0421 658840 or e-mail to info@keitaly.it

GENNIUS A4 autoportante doppia

CLIENTE (timbro) CUSTOMER (stamp)

Quantità/Q.ty _____ Riferimento/Reference _____

Data consegna richiesta/Required delivery date _____

TELO/FABRIC

- PVC PRECONSTRAINT 602 oscurante Bianco Opaco
black out matt white
- PVC PRECONSTRAINT 602 oscurante Avorio Opaco
black out matt ivory
- PVC PRECONSTRAINT 602 Bianco
White
- PVC PRECONSTRAINT 602 Avorio
Ivory
- Altro/Other _____

TELO LASCO/SLACK FABRIC

- Parallelo
Parallel
- Alternato
Alternated
- Asimmetrico
Asymmetrical

COLORAZIONI/COLOURS

STRUTTURA/STRUCTURE

- | | | |
|--|---|---|
| <input type="checkbox"/> RAL 9010 Bianco lucido
White | <input type="checkbox"/> RAL 8014 Marrone opaco
Matt brown | <input type="checkbox"/> Bianco antico
Ancient white |
| <input type="checkbox"/> RAL 9010 Bianco opaco
Matt white | <input type="checkbox"/> RAL 8017 Marrone
Brown | <input type="checkbox"/> Grigio ruvido
Rough grey |
| <input type="checkbox"/> RAL 1013 Avorio lucido
Ivory | <input type="checkbox"/> RAL 6005 Verde
Green | <input type="checkbox"/> Marrone antico
Ancient brown |
| <input type="checkbox"/> RAL 1013 Avorio opaco
Matt ivory | <input type="checkbox"/> RAL 3003 Rosso
Red | <input type="checkbox"/> Nero Inver
Inver black |
| <input type="checkbox"/> RAL 9006 Grigio
Grey | <input type="checkbox"/> RAL fuori standard
Non standard RAL | <input type="checkbox"/> Verde marmo antico
Ancient green marble |
| | | <input type="checkbox"/> Altro
Other |

ANODIZZATO / ANODIZED

- | | | |
|---|---|--|
| <input type="checkbox"/> Acciaio spazzolato lucido
Brushed steel | <input type="checkbox"/> Argento lucido
Brilliant Silver | <input type="checkbox"/> Bronzo chiaro
Light bronze |
| <input type="checkbox"/> Marrone
Brown | <input type="checkbox"/> Testa di moro
Dark brown | |

TRAVERSI/CROSSBAR PROFILES

- | | |
|--|--|
| <input type="checkbox"/> RAL 9010 Bianco lucido
White | <input type="checkbox"/> Altro
Other colour _____ |
| <input type="checkbox"/> RAL 1013 Avorio lucido
Ivory | |

OPTIONAL

- | | | |
|--|---|---|
| <input type="checkbox"/> Guarnizione antipioggia
Drain gasket | <input type="checkbox"/> Grondaia fissa
Fixed gutter | <input type="checkbox"/> Pluviale mobile
Downpipe mobile |
| <input type="checkbox"/> Tettuccio
Hood | <input type="checkbox"/> Tettuccio
Hood | |
- RAL 9010 RAL 1013

MOVIMENTAZIONE/MOVEMENT

- | | |
|---|---|
| <input type="checkbox"/> Motorizzazione KE
KE Motorization | <input type="checkbox"/> Motorizzazione SOMFY
SOMFY Motorization |
| <input type="checkbox"/> Motorizzazione SUNILUS IO
SUNILUS IO Motorization | <input type="checkbox"/> Motorizzazione PERGOLA IO
PERGOLA IO Motorization |

- | | | |
|-------------------------------|---|---|
| Telecomando
Remote control | <input type="checkbox"/> Monocanale
Single channel | <input type="checkbox"/> Multicanale
Multi-channel |
|-------------------------------|---|---|

2 GUIDE/GUIDES

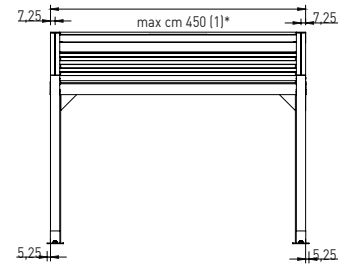

*500 cm fino a 1000 cm di sporgenza / 500 cm till 1000 cm of projection

DIMENSIONI/DIMENSIONS

- Larghezza
Width (1) cm _____
- Sporgenza
Projection (2) cm _____
- Altezza parete
Wall height (3) cm _____
- Altezza pilastri
Pilar height (4) cm _____

3 GUIDE/GUIDES

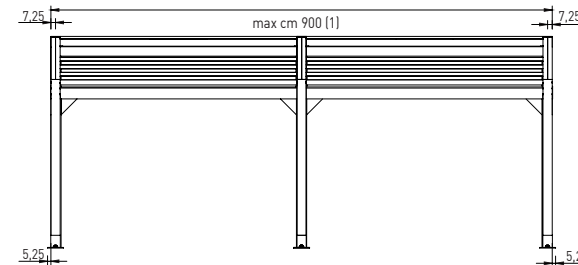

DIMENSIONI/DIMENSIONS

- Larghezza
Width (1) cm _____
- Sporgenza
Projection (2) cm _____
- Altezza parete
Wall height (3) cm _____
- Altezza pilastri
Pilar height (4) cm _____

4 GUIDE/GUIDES

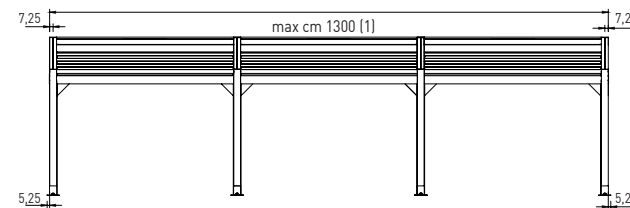

DIMENSIONI/DIMENSIONS

- Larghezza
Width (1) cm _____
- Sporgenza
Projection (2) cm _____
- Altezza parete
Wall height (3) cm _____
- Altezza pilastri
Pilar height (4) cm _____

2-3-4 GUIDE/GUIDES

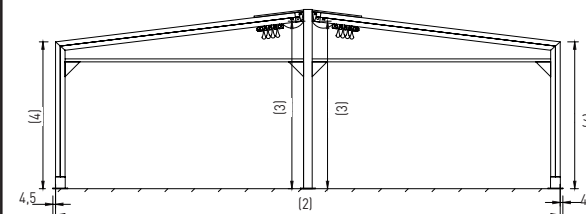

NOTE/NOTES

KE KE PROTEZIONI SOLARI - Inviare questo modulo al fax n. + 39 0421 658840 o via e-mail a info@keitaly.it
Send this order commission by fax to +39 0421 658840 or e-mail to info@keitaly.it

Quantità/Q.ty _____ Riferimento/Reference _____

Data consegna richiesta/Required delivery date _____

TELO/FABRIC

- PVC PRECONTRAI 602 oscurante Bianco Opaco
black out matt white
- PVC PRECONTRAI 602 oscurante Avorio Opaco
black out matt ivory
- PVC PRECONTRAI 602 Bianco
White
- PVC PRECONTRAI 602 Avorio
Ivory
- Altro/Other _____

TELO LASCO/SLACK FABRIC

- Parallelo
Parallel
- Alternato
Alternated
- Asimmetrico
Asymmetrical

COLORAZIONI/COLOURS

STRUTTURA/STRUCTURE

- Mogano semilucido Mahogany semi-glossy
- Antracite semilucido Anthracite
- Altro Other _____

GUIDE/GUIDES

- RAL 9010 Bianco lucido
White
- RAL 1013 Avorio lucido
Ivory
- RAL 8014 Marrone opaco
Matt brown
- Altro Other colour _____

TRAVERSI/CROSSBAR PROFILES

- RAL 9010 Bianco lucido
White
- RAL 1013 Avorio lucido
Ivory
- Altro Other colour _____

OPTIONAL

- Guarnizione anti-pioggia Drain gasket
- Copriarcareccio Coverpurlin
- Kit Luci Lights Kit
- Tettuccio Hood RAL 9010
- Tettuccio Hood RAL 1013

COLORE ACCESSORI (GRONDAIA, PLUVIALE, PIEDINO) / COLOR ACCESSORIES (GUTTER, DOWNPIPE, LEG)

- RAL 9010 Bianco lucido White
- RAL 8014 Marrone opaco Matt brown
- RAL 1013 Avorio lucido Ivory
- Nero Inver Inver black
- Altro Other colour _____

MOVIMENTAZIONE/MOVEMENT

*Solo per modello 2 GUIDE/Only for 2-guides-model

- Manuale* Asta Manual*with crank rod cm _____
- Lato (vista frontale) Side (frontal side) _____
- Motorizzazione KE KE Motorization
- Motorizzazione SOMFY SOMFY Motorization
- Motorizzazione SUNILUS IO SUNILUS IO Motorization
- Motorizzazione PERGOLA IO PERGOLA IO Motorization
- Telecomando Remote control
- Monocanale Single channel
- Multicanale Multi-channel

POSA/INSTALLATION

- Parete Wall
- Soffitto Ceiling

TESTATA/HEAD

A



B



C



2 GUIDE/GUIDES

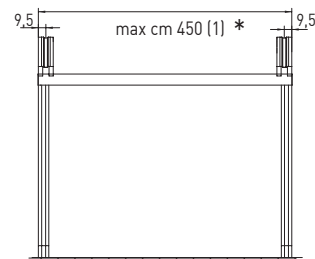

*500 cm fino a 500 cm di sporgenza / 500 cm till 500 cm of projection

DIMENSIONI/DIMENSIONS

Larghezza Width	(1) cm	_____
Sporgenza Projection	(2) cm	_____
Altezza parete Wall height	(3) cm	_____
Altezza pilastri Pilar height	(4) cm	_____
Altezza soffitto Ceiling height	(5) cm	_____

3 GUIDE/GUIDES

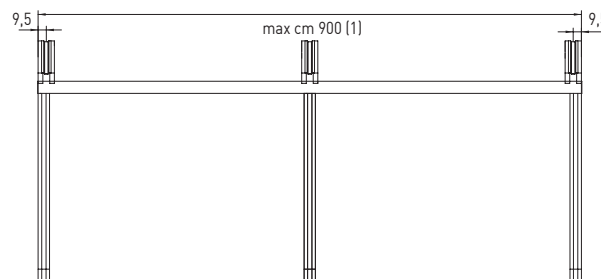

DIMENSIONI/DIMENSIONS

Larghezza Width	(1) cm	_____
Sporgenza Projection	(2) cm	_____
Altezza parete Wall height	(3) cm	_____
Altezza pilastri Pilar height	(4) cm	_____
Altezza soffitto Ceiling height	(5) cm	_____

4 GUIDE/GUIDES

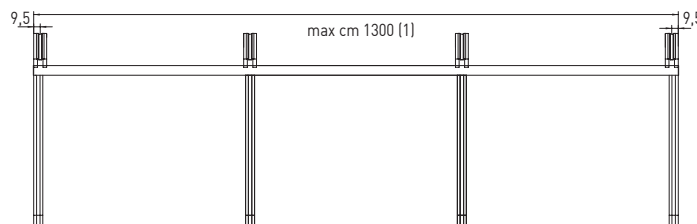

DIMENSIONI/DIMENSIONS

Larghezza Width	(1) cm	_____
Sporgenza Projection	(2) cm	_____
Altezza parete Wall height	(3) cm	_____
Altezza pilastri Pilar height	(4) cm	_____
Altezza soffitto Ceiling height	(5) cm	_____

2-3-4 GUIDE/GUIDES

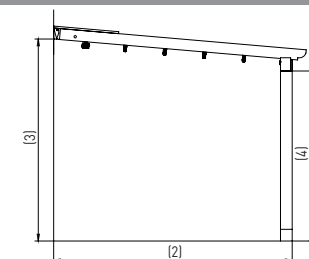

NOTE/NOTES

CLIENTE (timbro) CUSTOMER (stamp)

Quantità/Q.ty _____

Riferimento/Reference _____

Data consegna richiesta/Required delivery date _____

TELO/FABRIC

- | | |
|--|--|
| <input type="checkbox"/> PVC PRECONSTRAINT 602 | oscurante Bianco Opaco
black out matt white |
| <input type="checkbox"/> PVC PRECONSTRAINT 602 | oscurante Avorio Opaco
black out matt ivory |
| <input type="checkbox"/> PVC PRECONSTRAINT 602 | Bianco
White |
| <input type="checkbox"/> PVC PRECONSTRAINT 602 | Avorio
Ivory |
| <input type="checkbox"/> Altro/Other | _____ |

TELO LASCO/SLACK FABRIC

- | |
|--|
| <input type="checkbox"/> Parallelo
Parallel |
| <input type="checkbox"/> Alternato
Alternated |
| <input type="checkbox"/> Asimmetrico
Asymmetrical |

COLORAZIONI/COLOURS
STRUTTURA/STRUCTURE

- | | | |
|--|---|---|
| <input type="checkbox"/> Mogano semilucido
Mahogany semi-glossy | <input type="checkbox"/> Antracite semilucido
Anthracite | <input type="checkbox"/> Altro
Other _____ |
|--|---|---|

GUIDE/GUIDES

- | |
|---|
| <input type="checkbox"/> RAL 9010 Bianco lucido
White |
| <input type="checkbox"/> RAL 1013 Avorio lucido
Ivory |
| <input type="checkbox"/> RAL 8014 Marrone opaco
Matt brown |
| <input type="checkbox"/> Altro
Other colour _____ |

TRAVERSI/CROSSBAR PROFILES

- | |
|--|
| <input type="checkbox"/> RAL 9010 Bianco lucido
White |
| <input type="checkbox"/> RAL 1013 Avorio lucido
Ivory |
| <input type="checkbox"/> Altro
Other colour _____ |

OPTIONAL

- | | | |
|---|---|---|
| <input type="checkbox"/> Guarnizione anti-pioggia
Drain gasket | <input type="checkbox"/> Testata laterale
Lateral head | <input type="checkbox"/> Kit Luci
Lights Kit |
| <input type="checkbox"/> Tettuccio
Hood RAL 9010 | <input type="checkbox"/> Tettuccio
Hood RAL 1013 | |

COLORE GRONDAIA / GUTTER COLOUR

- | | | |
|--|---|--|
| <input type="checkbox"/> RAL 9010 Bianco lucido
White | <input type="checkbox"/> RAL 8014 Marrone opaco
Matt brown | <input type="checkbox"/> Altro
Other colour _____ |
| <input type="checkbox"/> RAL 1013 Avorio lucido
Ivory | <input type="checkbox"/> Nero Inver
Inver black | |

MOVIMENTAZIONE/MOVEMENT

- | | |
|---|---|
| <input type="checkbox"/> Motorizzazione KE
KE Motorization | <input type="checkbox"/> Motorizzazione SOMFY
SOMFY Motorization |
| <input type="checkbox"/> Motorizzazione SUNILUS IO
SUNILUS IO Motorization | <input type="checkbox"/> Motorizzazione PERGOLA IO
PERGOLA IO Motorization |
| Telecomando
Remote control | <input type="checkbox"/> Monocanale
Single channel <input type="checkbox"/> Multicanale
Multi-channel |

POSA/INSTALLATION

- | | |
|---|--|
| <input type="checkbox"/> Parete
Wall | <input type="checkbox"/> Soffitto
Ceiling |
|---|--|

TESTATA/HEAD

A



B

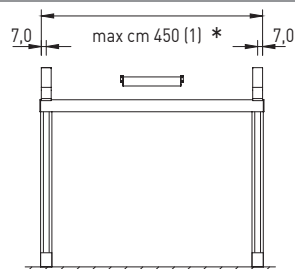

C

2 GUIDE/GUIDES

*500 cm fino a 500 cm di sporgenza / 500 cm till 500 cm of projection

DIMENSIONI/DIMENSIONS

Larghezza Width	(1) cm	_____
Sporgenza Projection	(2) cm	_____
Altezza parete Wall height	(3) cm	_____
Altezza pilastri Pilar height	(4) cm	_____
Altezza soffitto Ceiling height	(5) cm	_____

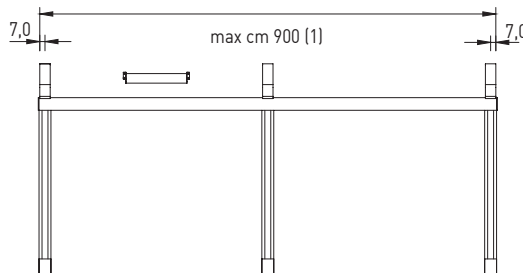
3 GUIDE/GUIDES

DIMENSIONI/DIMENSIONS

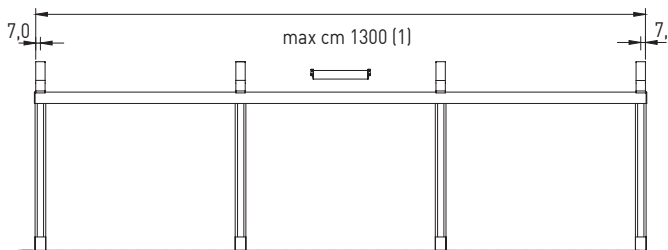
Larghezza Width	(1) cm	_____
Sporgenza Projection	(2) cm	_____
Altezza parete Wall height	(3) cm	_____
Altezza pilastri Pilar height	(4) cm	_____
Altezza soffitto Ceiling height	(5) cm	_____

4 GUIDE/GUIDES

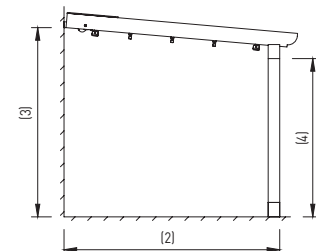
DIMENSIONI/DIMENSIONS

Larghezza Width	(1) cm	_____
Sporgenza Projection	(2) cm	_____
Altezza parete Wall height	(3) cm	_____
Altezza pilastri Pilar height	(4) cm	_____
Altezza soffitto Ceiling height	(5) cm	_____

2-3-4 GUIDE/GUIDES

NOTE/NOTES

KE PROTEZIONI SOLARI - Inviare questo modulo al fax n. +39 0421 658840 o via e-mail a info@keitaly.it

Send this order commission by fax to +39 0421 658840 or e-mail to info@keitaly.it

CLIENTE (timbro) CUSTOMER (stamp)

Quantità/Q.ty _____ Riferimento/Reference _____

Data consegna richiesta/Required delivery date _____

TESSUTO/FABRIC

Soltis 92 cod. _____

Altro _____

COLORAZIONI/COLOURS

RAL 9010 Bianco lucido White RAL 1013 Avorio lucido Ivory Nero Inver Inver black

RAL fuori standard Non standard RAL RAL 8014 Marrone opaco Matt brown Altro colore Other colour _____

ANODIZZATO / ANODIZED

Acciaio spazzolato lucido Brushed steel Argento lucido Brilliant Silver Bronzo chiaro Light bronze

Marrone Brown Testa di moro Dark brown

MOVIMENTAZIONE/MOUMENT

Motorizzazione KE KE Motorization Motorizzazione SOMFY SOMFY Motorization

Motorizzazione SUNILUS IO SUNILUS IO Motorization Motorizzazione PERGOLA IO PERGOLA IO Motorization

Telecomando Remote control Monocanale Single channel Multicanale Multi-channel

DIMENSIONI/DIMENSIONS

Larghezza Width (1) cm _____

Sporgenza Projection (2) cm _____

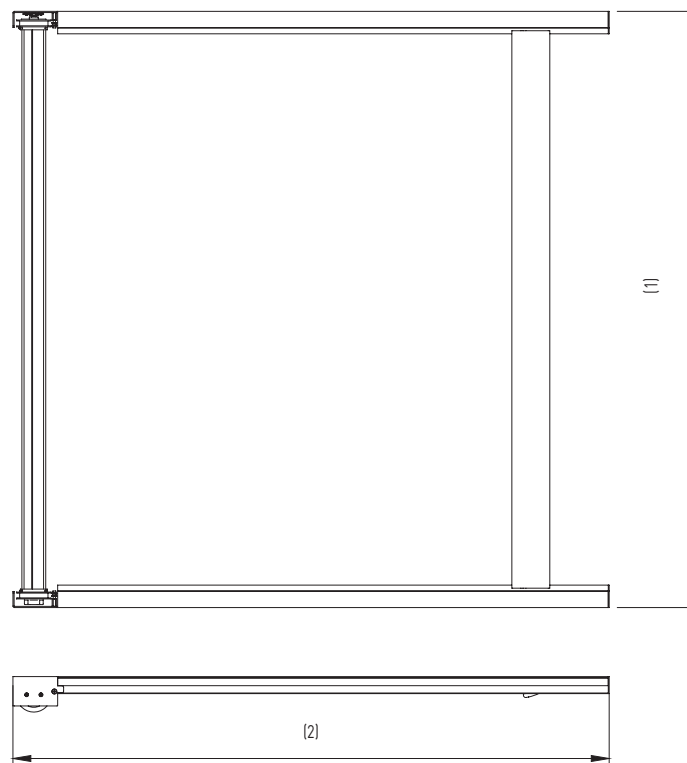

NOTE/NOTES

CLIENTE (timbro) CUSTOMER (stamp)

Quantità/Q.ty _____ Riferimento/Reference _____

Data consegna richiesta/Required delivery date _____

TELO/FABRIC

- SOLTIS W96 cod. _____
- SOLTIS 92 cod. _____
- Altro/Other _____

COLORAZIONI/COLOURS

STRUTTURA/STRUCTURE

- RAL 9010 Bianco White
- Nero Inver Inver black
- Altro RAL _____
Other RAL _____

ANODIZZATO / ANODIZED

- Acciaio spazzolato lucido Brushed steel
- Argento lucido Brilliant Silver
- Bronzo chiaro Light bronze
- Marrone Brown
- Testa di moro Dark brown

MOVIMENTAZIONE/MOVEMENT

- KE
- Motorizzazione RTS Motorization RTS
- SOMFY
- SOMFY IO
- Telecomando Remote control
- Monocanale Single channel
- Motorizzazione CAVO Motorization CABLE
- KE
- SOMFY
- Multicanale Multi-channel

QUADRO - SQUARE

A-A

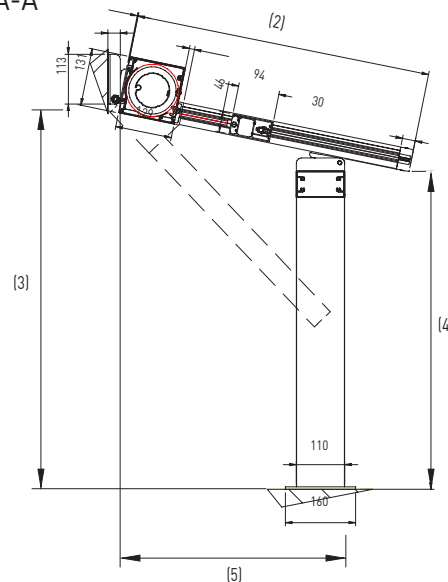

DIMENSIONI/DIMENSIONS

- Larghezza Width (1) cm _____
- Sporgenza Projection (2) cm _____
- Altezza parete Wall height (3) cm _____
- Altezza pilastri Pilar height (4) cm _____
- Sporgenza a terra Floor projection (5) cm _____

VISTA FRONTALE - FRONTAL VIEW

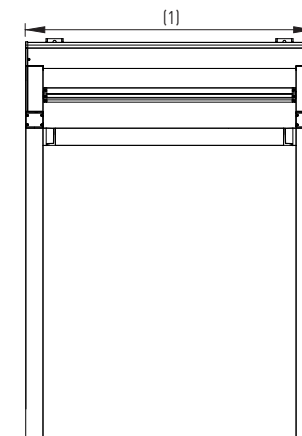

NOTE/NOTES

CLIENTE (timbro) CUSTOMER (stamp)

Quantità/Q.ty _____ Riferimento/Reference _____

Data consegna richiesta/Required delivery date _____

MODELLI/MODELS

 Apertura (A) cm _____ Boma (B) cm _____
 Opening Boom

TESSUTO/FABRIC
 Tempotest Star Resinato cod. _____
 Tempotest Star Light cod. _____
 Dacron Laminato Rolled Dacron
 Soltis 92 cod. _____

OPTIONAL

<input type="checkbox"/> Copripiedino inclinato Inclined cover foot	Q.tà _____ Q.ty _____	<input type="checkbox"/> Copripiedino dritto Straight cover foot	Q.tà _____ Q.ty _____
<input type="checkbox"/> Telecomando ad 1 canale T1 1 channel remote control T1	Q.tà _____ Q.ty _____	<input type="checkbox"/> Telecomando a 5 canali T2 5 channels remote control T2	Q.tà _____ Q.ty _____
<input type="checkbox"/> Sensore wireless sole/vento SENSO 01 Sun and wind wireless sensor Senso 01	Q.tà/Q.ty _____		
<input type="checkbox"/> Supporto inox per sensore wireless sole/vento SENSO 01 Steel support for sun/wind wireless sensor Senso 01	Q.tà/Q.ty _____		
<input type="checkbox"/> Faro per illuminazione con supporto a muro Light with wall support	Q.tà/Q.ty _____		
<input type="checkbox"/> Faro per illuminazione con supporto ad albero Light with shaft support	Q.tà/Q.ty _____		
<input type="checkbox"/> Piastra zavorrabile completa di coprizavorra per albero dritto Plate with ballast-option, ballast case for straight shaft included	Q.tà/Q.ty _____		
<input type="checkbox"/> Piastra zavorrabile completa di coprizavorra per albero inclinato Plate with ballast-option, ballast case for bowed shaft included	Q.tà/Q.ty _____		

ACCESSORI PER INSTALLAZIONE /INSTALLATION TOOLS

<input type="checkbox"/> Cesoia per funi in acciaio Shear for steel cables	Q.tà/Q.ty _____
<input type="checkbox"/> Pressa idraulica manuale/fune Hydraulic manual/rope press	Q.tà/Q.ty _____
<input type="checkbox"/> Pressa idraulica manuale/fune + cesoia per funi Hydraulic manual/rope press + rope cutter	Conf./Pack. _____

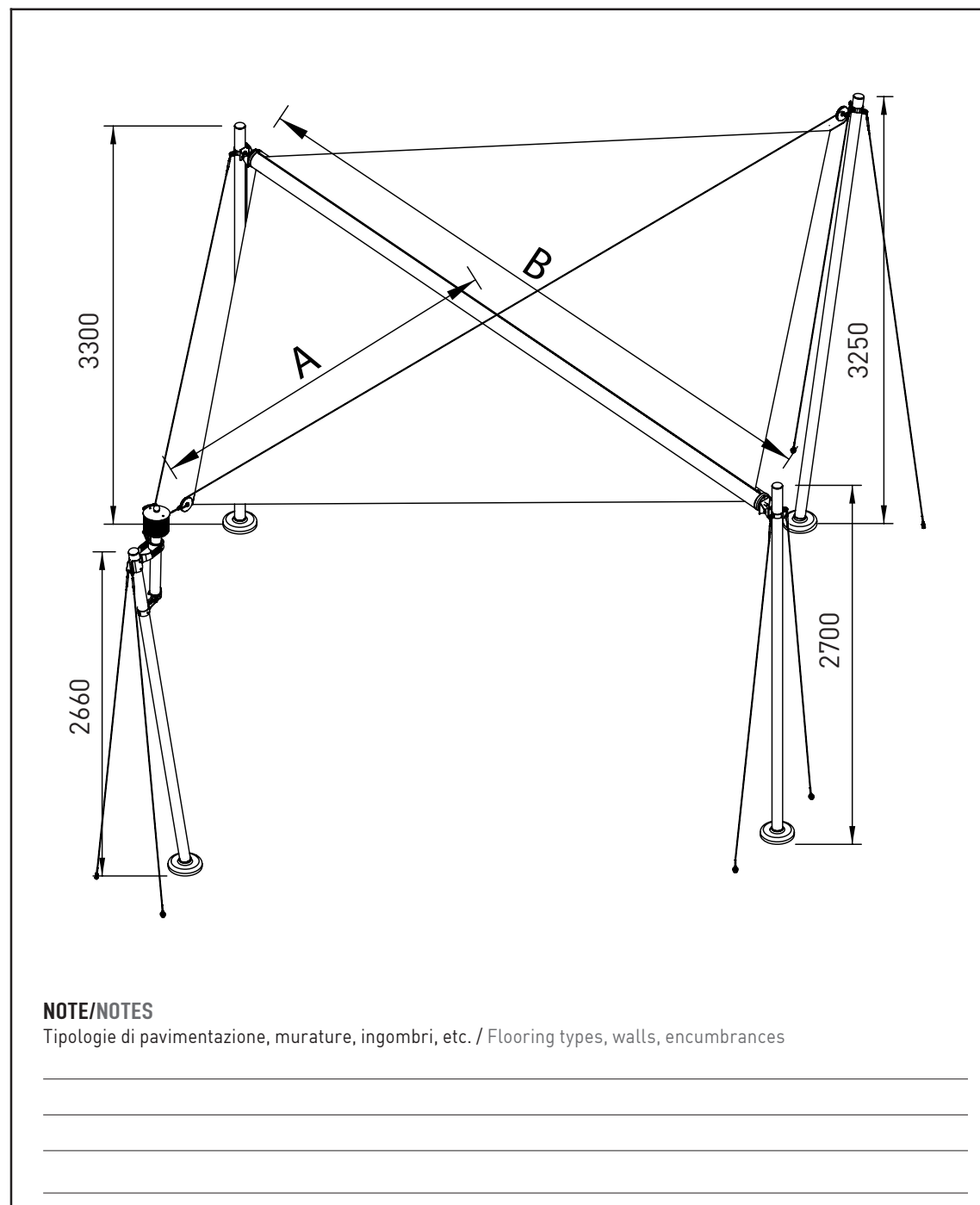
NOTE/NOTES

Tipologie di pavimentazione, murature, ingombri, etc. / Flooring types, walls, encumbrances

Quantità/Q.ty _____ Riferimento/Reference _____

Data consegna richiesta/Required delivery date _____

MODELLI/MODELS

Apertura (A) cm _____ Boma (B) cm _____
Opening Boom

TESSUTO/FABRIC

- | | |
|---|--|
| <input type="checkbox"/> Tempotest Star Resinato cod. _____ | <input type="checkbox"/> Dacron Laminato Rolled Dacron |
| <input type="checkbox"/> Tempotest Star Light cod. _____ | <input type="checkbox"/> Soltis 92 cod. _____ |

OPTIONAL

- | | |
|--|--|
| <input type="checkbox"/> Copripiedino inclinato Q.tà _____
Inclined cover foot Q.ty | <input type="checkbox"/> Copripiedino dritto Q.tà _____
Straight cover foot Q.ty |
| <input type="checkbox"/> Telecomando ad 1 canale T1 Q.tà _____
1 channel remote control T1 Q.ty | <input type="checkbox"/> Telecomando a 5 canali T2 Q.tà _____
5 channels remote control T2 Q.ty |
| <input type="checkbox"/> Sensore wireless sole/vento SENSO 01 Q.tà/Q.ty _____
Sun and wind wireless sensor Senso 01 | |
| <input type="checkbox"/> Supporto inox per sensore wireless sole/vento SENSO 01 Q.tà/Q.ty _____
Steel support for sun/wind wireless sensor Senso 01 | |
| <input type="checkbox"/> Faro per illuminazione con supporto a muro Q.tà/Q.ty _____
Light with wall support | |
| <input type="checkbox"/> Faro per illuminazione con supporto ad albero Q.tà/Q.ty _____
Light with shaft support | |
| <input type="checkbox"/> Piastra zavorrabile completa di coprizavorra per albero dritto Q.tà/Q.ty _____
Plate with ballast-option, ballast case for straight shaft included | |
| <input type="checkbox"/> Piastra zavorrabile completa di coprizavorra per albero inclinato Q.tà/Q.ty _____
Plate with ballast-option, ballast case for bowed shaft included | |

ACCESSORI PER INSTALLAZIONE /INSTALLATION TOOLS

- | | |
|---|--|
| <input type="checkbox"/> Cesoia per funi in acciaio Q.tà/Q.ty _____
Shear for steel cables | |
| <input type="checkbox"/> Pressa idraulica manuale/fune Q.tà/Q.ty _____
Hydraulic manual/rope press | |
| <input type="checkbox"/> Pressa idraulica manuale/fune + cesoia per funi Conf./Pack. _____
Hydraulic manual/rope press + rope cutter | |

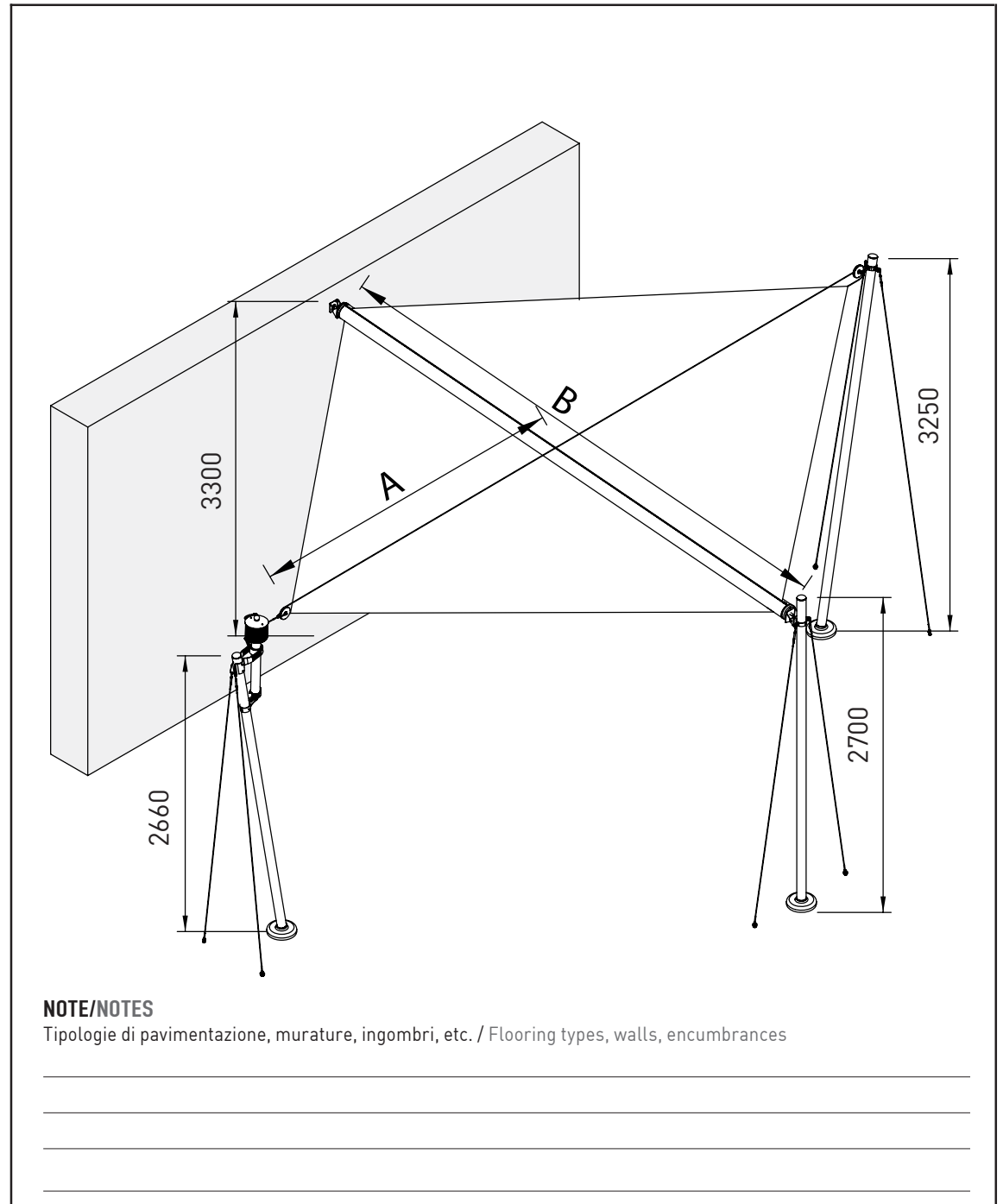

NOTE/NOTES

Tipologie di pavimentazione, murature, ingombri, etc. / Flooring types, walls, encumbrances

Quantità/Q.ty _____ Riferimento/Reference _____

Data consegna richiesta/Required delivery date _____

MODELLI/MODELS

Apertura (A) cm _____ Boma (B) cm _____
Opening Boom

TESSUTO/FABRIC

- Tempotest Star Resinato cod. _____
- Dacron Laminato Rolled Dacron
- Tempotest Star Light cod. _____
- Soltis 92 cod. _____

OPTIONAL

- Copripiedino inclinato Q.tà _____ Copripiedino dritto Q.tà _____
Inclined cover foot Q.ty Straight cover foot Q.ty
- Telecomando ad 1 canale T1 Q.tà _____ Telecomando a 5 canali T2 Q.tà _____
1 channel remote control T1 Q.ty 5 channels remote control T2 Q.ty
- Sensore wireless sole/vento SENSO 01 Q.tà/Q.ty _____
Sun and wind wireless sensor Senso 01
- Supporto inox per sensore wireless sole/vento SENSO 01 Q.tà/Q.ty _____
Steel support for sun/wind wireless sensor Senso 01
- Faro per illuminazione con supporto a muro Q.tà/Q.ty _____
Light with wall support
- Faro per illuminazione con supporto ad albero Q.tà/Q.ty _____
Light with shaft support
- Piastra zavorrabile completa di coprizavorra per albero dritto Q.tà/Q.ty _____
Plate with ballast-option, ballast case for straight shaft included
- Piastra zavorrabile completa di coprizavorra per albero inclinato Q.tà/Q.ty _____
Plate with ballast-option, ballast case for bowed shaft included

ACCESSORI PER INSTALLAZIONE /INSTALLATION TOOLS

- Cesoia per funi in acciaio Q.tà/Q.ty _____
Shear for steel cables
- Pressa idraulica manuale/fune Q.tà/Q.ty _____
Hydraulic manual/rope press
- Pressa idraulica manuale/fune + cesoia per funi Conf./Pack. _____
Hydraulic manual/rope press + rope cutter

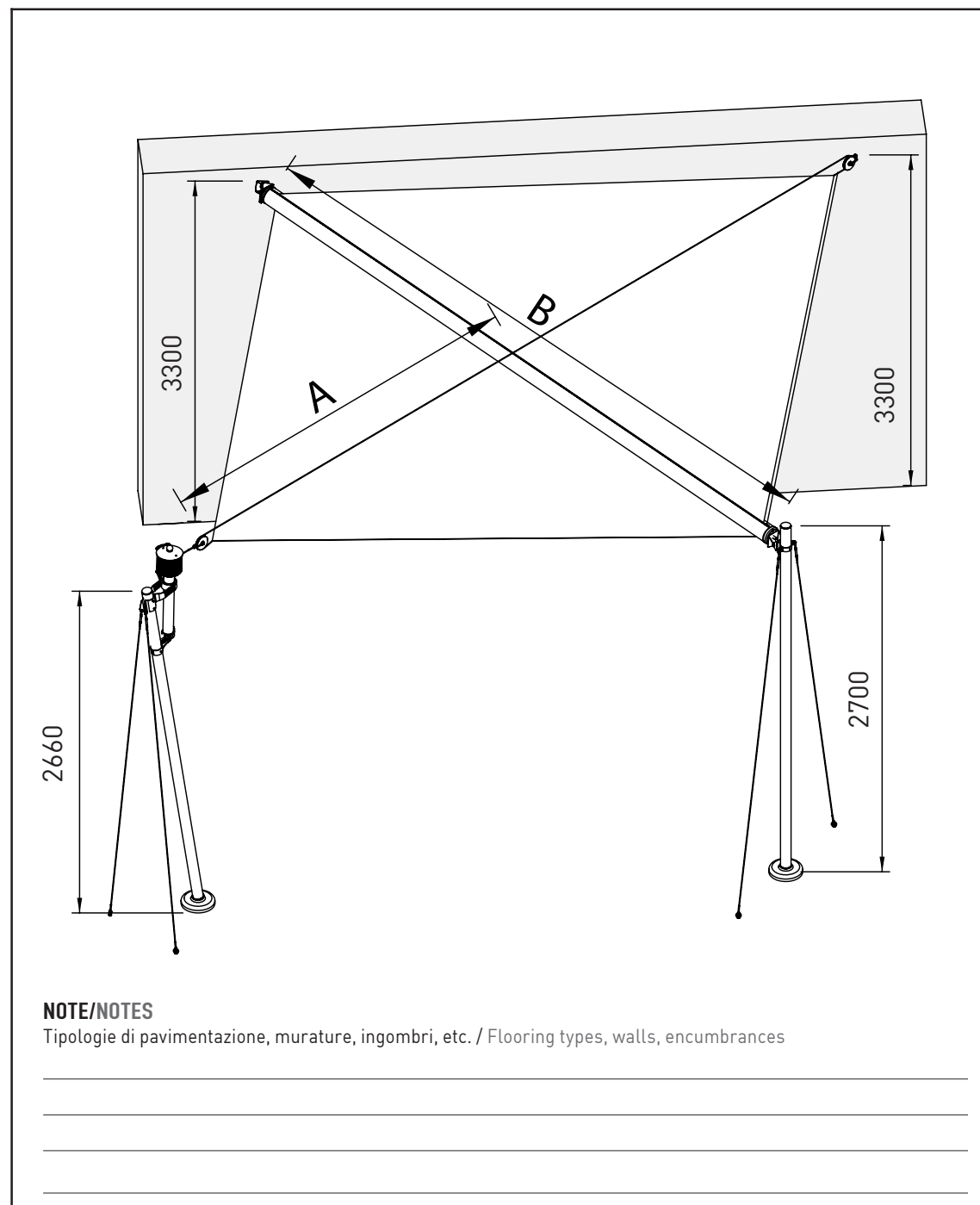

NOTE/NOTES

Tipologie di pavimentazione, murature, ingombri, etc. / Flooring types, walls, encumbrances

Quantità/Q.ty _____ Riferimento/Reference _____

Data consegna richiesta/Required delivery date _____

MODELLI/MODELS

Apertura (A) cm _____ Boma (B) cm _____
Opening Boom

TESSUTO/FABRIC

- Tempotest Star Resinato cod. _____ Dacron Laminato Rolled Dacron
 Tempotest Star Light cod. _____ Soltis 92 cod. _____

OPTIONAL

- Copripiedino inclinato Q.tà _____ Copripiedino dritto Q.tà _____
Inclined cover foot Q.ty Straight cover foot Q.ty
 Telecomando ad 1 canale T1 Q.tà _____ Telecomando a 5 canali T2 Q.tà _____
1 channel remote control T1 Q.ty 5 channels remote control T2 Q.ty
 Sensore wireless sole/vento SENSO 01 Q.tà/Q.ty _____
Sun and wind wireless sensor Senso 01
 Supporto inox per sensore wireless sole/vento SENSO 01 Q.tà/Q.ty _____
Steel support for sun/wind wireless sensor Senso 01
 Faro per illuminazione con supporto a muro Q.tà/Q.ty _____
Light with wall support
 Faro per illuminazione con supporto ad albero Q.tà/Q.ty _____
Light with shaft support
 Piastra zavorrabile completa di coprizavorra per albero dritto Q.tà/Q.ty _____
Plate with ballast-option, ballast case for straight shaft included
 Piastra zavorrabile completa di coprizavorra per albero inclinato Q.tà/Q.ty _____
Plate with ballast-option, ballast case for bowed shaft included

ACCESSORI PER INSTALLAZIONE /INSTALLATION TOOLS

- Cesoia per funi in acciaio Q.tà/Q.ty _____
Shear for steel cables
 Pressa idraulica manuale/fune Q.tà/Q.ty _____
Hydraulic manual/rope press
 Pressa idraulica manuale/fune + cesoia per funi Conf./Pack. _____
Hydraulic manual/rope press + rope cutter

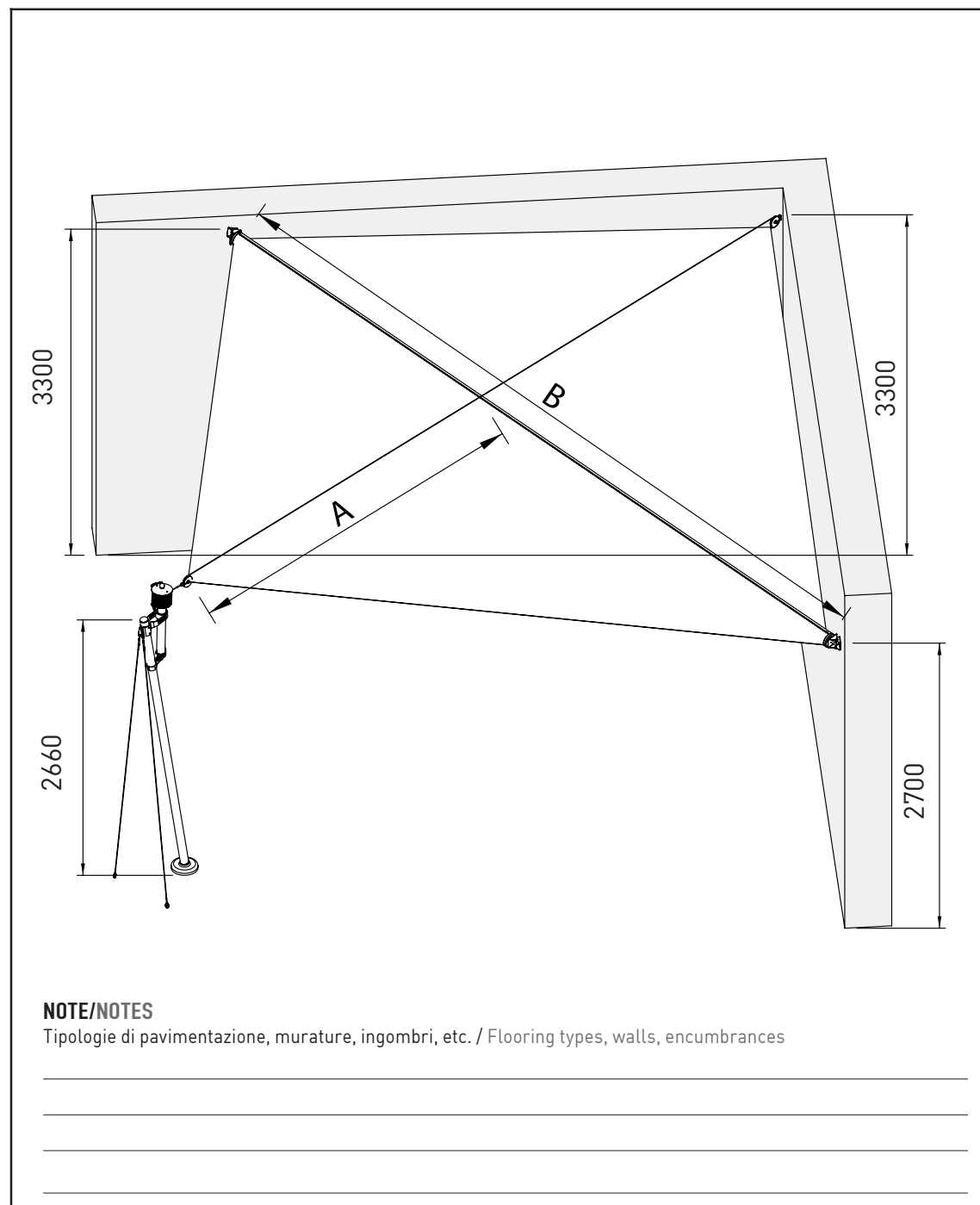

NOTE/NOTES

Tipologie di pavimentazione, murature, ingombri, etc. / Flooring types, walls, encumbrances

Quantità/Q.ty _____ Riferimento/Reference _____

Data consegna richiesta/Required delivery date _____

MODELLI/MODELS

Apertura (A) cm _____ Boma (B) cm _____
Opening Boom

TESSUTO/FABRIC

- Tempotest Star Resinato cod. _____ Dacron Laminato Rolled Dacron
 Tempotest Star Light cod. _____ Soltis 92 cod. _____

OPTIONAL

- Copripiedino inclinato Q.tà _____ Copripiedino dritto Q.tà _____
Inclined cover foot Q.ty Straight cover foot Q.ty
- Telecomando ad 1 canale T1 Q.tà _____ Telecomando a 5 canali T2 Q.tà _____
1 channel remote control T1 Q.ty 5 channels remote control T2 Q.ty
- Sensore wireless sole/vento SENSO 01 Q.tà/Q.ty _____
Sun and wind wireless sensor Senso 01
- Supporto inox per sensore wireless sole/vento SENSO 01 Q.tà/Q.ty _____
Steel support for sun/wind wireless sensor Senso 01
- Faro per illuminazione con supporto a muro Q.tà/Q.ty _____
Light with wall support
- Faro per illuminazione con supporto ad albero Q.tà/Q.ty _____
Light with shaft support
- Piastra zavorrabile completa di coprizavorra per albero dritto Q.tà/Q.ty _____
Plate with ballast-option, ballast case for straight shaft included
- Piastra zavorrabile completa di coprizavorra per albero inclinato Q.tà/Q.ty _____
Plate with ballast-option, ballast case for bowed shaft included

ACCESSORI PER INSTALLAZIONE /INSTALLATION TOOLS

- Cesoia per funi in acciaio Q.tà/Q.ty _____
Shear for steel cables
- Pressa idraulica manuale/fune Q.tà/Q.ty _____
Hydraulic manual/rope press
- Pressa idraulica manuale/fune + cesoia per funi Conf./Pack. _____
Hydraulic manual/rope press + rope cutter

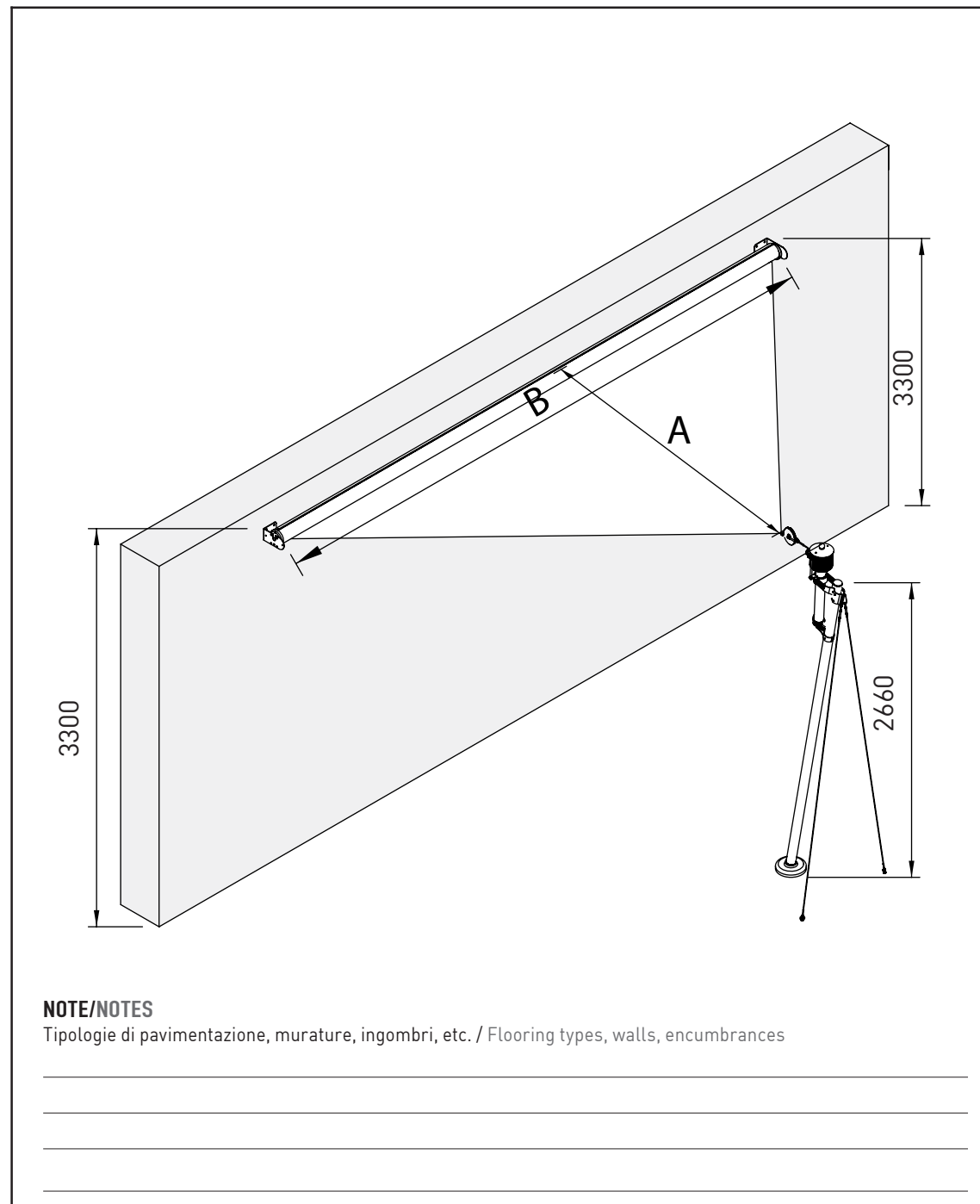

NOTE/NOTES

Tipologie di pavimentazione, murature, ingombri, etc. / Flooring types, walls, encumbrances

GENNIUS EASY SAILS E1

CLIENTE (timbro) CUSTOMER (stamp)

Quantità/Q.ty _____

Data consegna richiesta/Required delivery date _____ Riferimento/Reference _____

COLORAZIONI/COLOURS
STRUTTURA/STRUCTURE

- | | |
|---|--|
| <input type="checkbox"/> Bianco
White | <input type="checkbox"/> Antracite
Anthracite |
| <input type="checkbox"/> Silver
Silver | <input type="checkbox"/> Bronzo
Bronze |

DIMENSIONI/DIMENSIONS

(A) cm _____ (B) cm _____

- | | |
|--|---|
| <input type="checkbox"/> N° Pali
N° Poles _____ | <input type="checkbox"/> N° Supporti parete
N° wall supports _____ |
|--|---|

TESSUTO/FABRIC

- | | |
|---|---|
| <input type="checkbox"/> TEXTILENE cod. _____ | <input type="checkbox"/> Dacron Laminato
Rolled Dacron |
| <input type="checkbox"/> SUMBRELLA cod. _____ | <input type="checkbox"/> TENTMESH cod. _____ |

ALTEZZA PALI/HEIGHT POLES

- 2,8 MT 3,2 MT

OPTIONAL

- | | | | |
|--|--------------------|---|--------------------|
| <input type="checkbox"/> Supporto 75° per palo
75° support for pole | Q.tà _____
Q.ty | <input type="checkbox"/> Carter per supporti
Carter for supports | Q.tà _____
Q.ty |
|--|--------------------|---|--------------------|

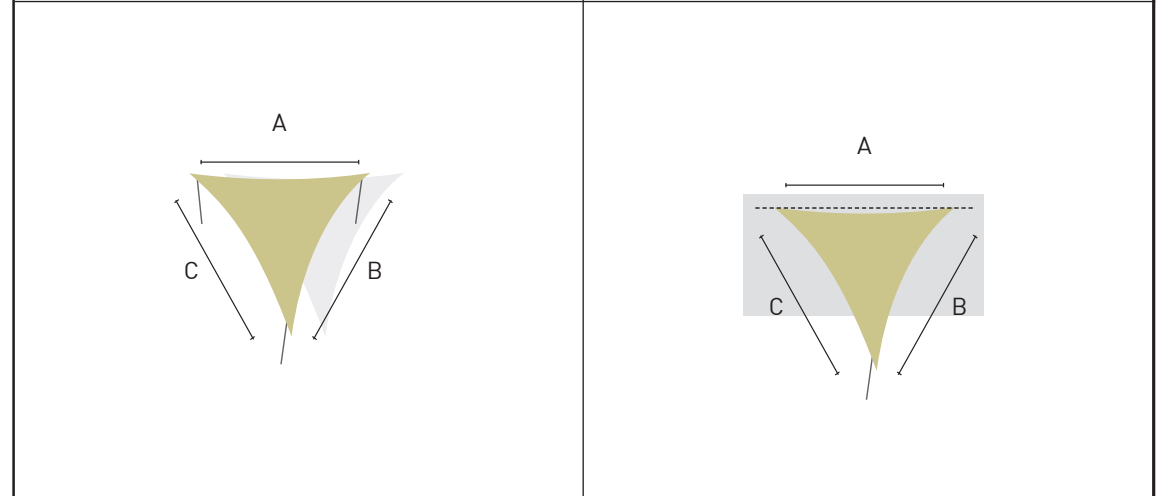
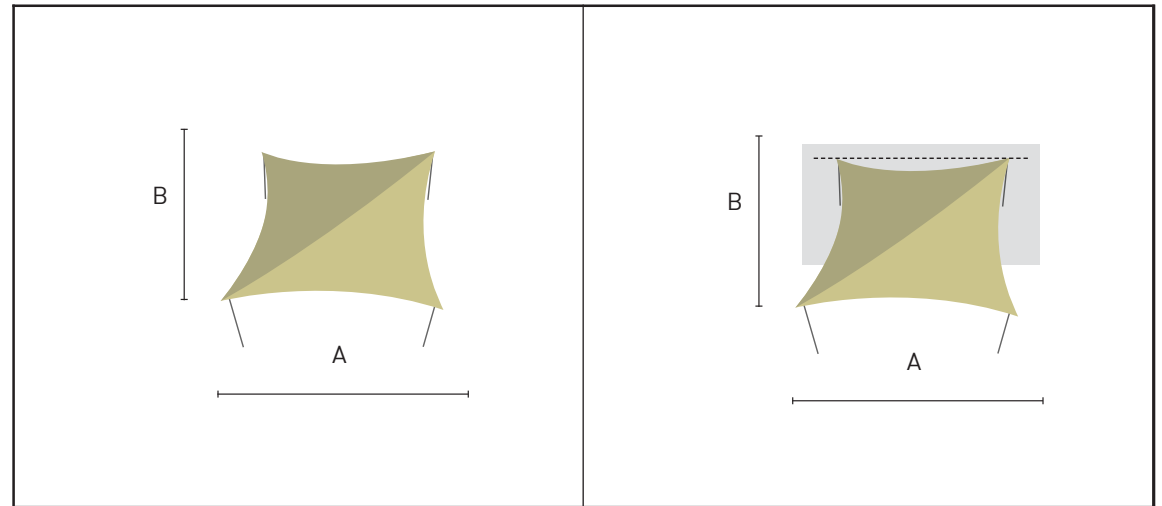

NOTE/NOTES

GENNIUS EASY SAILS E2

CLIENTE (timbro) CUSTOMER (stamp)

Quantità/Q.ty _____

Data consegna richiesta/Required delivery date _____ Riferimento/Reference _____

COLORAZIONI/COLOURS
STRUTTURA/STRUCTURE

- | | |
|---|--|
| <input type="checkbox"/> Bianco
White | <input type="checkbox"/> Antracite
Anthracite |
| <input type="checkbox"/> Silver
Silver | <input type="checkbox"/> Bronzo
Bronze |

DIMENSIONI/DIMENSIONS

(A) cm _____ (B) cm _____

- | | |
|--|---|
| <input type="checkbox"/> N° Pali
N° Poles _____ | <input type="checkbox"/> N° Supporti parete
N° wall supports _____ |
|--|---|

TESSUTO/FABRIC

- | | |
|---|---|
| <input type="checkbox"/> TEXTILENE cod. _____ | <input type="checkbox"/> Dacron Laminato
Rolled Dacron |
| <input type="checkbox"/> SUMBRELLA cod. _____ | <input type="checkbox"/> TENTMESH cod. _____ |

ALTEZZA PALI/HEIGHT POLES

- 2,8 MT 3,2 MT

OPTIONAL

- | | | | |
|--|--------------------|---|--------------------|
| <input type="checkbox"/> Supporto 75° per palo
75° support for pole | Q.tà _____
Q.ty | <input type="checkbox"/> Carter per supporti
Carter for supports | Q.tà _____
Q.ty |
|--|--------------------|---|--------------------|

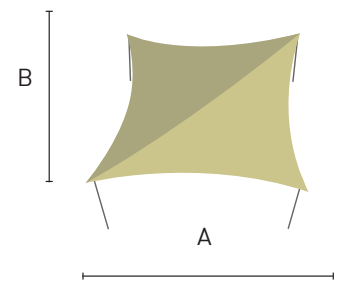
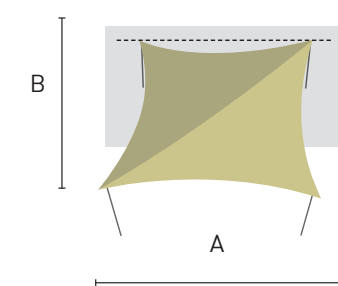
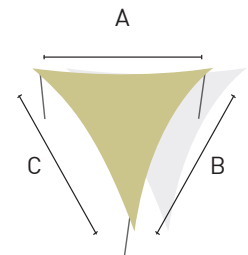
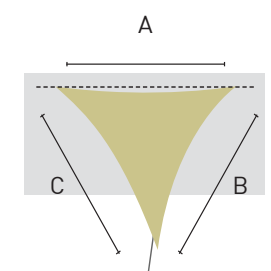
	
	
<p>NOTE/NOTES</p> <hr/> <hr/> <hr/> <hr/> <hr/> <hr/> <hr/> <hr/> <hr/> <hr/>	

GENNIUS EASY SAILS E3

CLIENTE (timbro) CUSTOMER (stamp)

Quantità/Q.ty _____

Data consegna richiesta/Required delivery date _____ Riferimento/Reference _____

COLORAZIONI/COLOURS
STRUTTURA/STRUCTURE

- | | |
|---|--|
| <input type="checkbox"/> Bianco
White | <input type="checkbox"/> Antracite
Anthracite |
| <input type="checkbox"/> Silver
Silver | <input type="checkbox"/> Bronzo
Bronze |

DIMENSIONI/DIMENSIONS

(A) cm _____ (B) cm _____

- | | |
|--|---|
| <input type="checkbox"/> N° Pali
N° Poles _____ | <input type="checkbox"/> N° Supporti parete
N° wall supports _____ |
|--|---|

TESSUTO/FABRIC

- | | |
|---|---|
| <input type="checkbox"/> TEXTILENE cod. _____ | <input type="checkbox"/> Dacron Laminato
Rolled Dacron |
| <input type="checkbox"/> SUMBRELLA cod. _____ | <input type="checkbox"/> TENTMESH cod. _____ |

ALTEZZA PALI/HEIGHT POLES

- 2,8 MT 3,2 MT

OPTIONAL

- | | | | |
|--|--------------------|---|--------------------|
| <input type="checkbox"/> Supporto 75° per palo
75° support for pole | Q.tà _____
Q.ty | <input type="checkbox"/> Carter per supporti
Carter for supports | Q.tà _____
Q.ty |
|--|--------------------|---|--------------------|

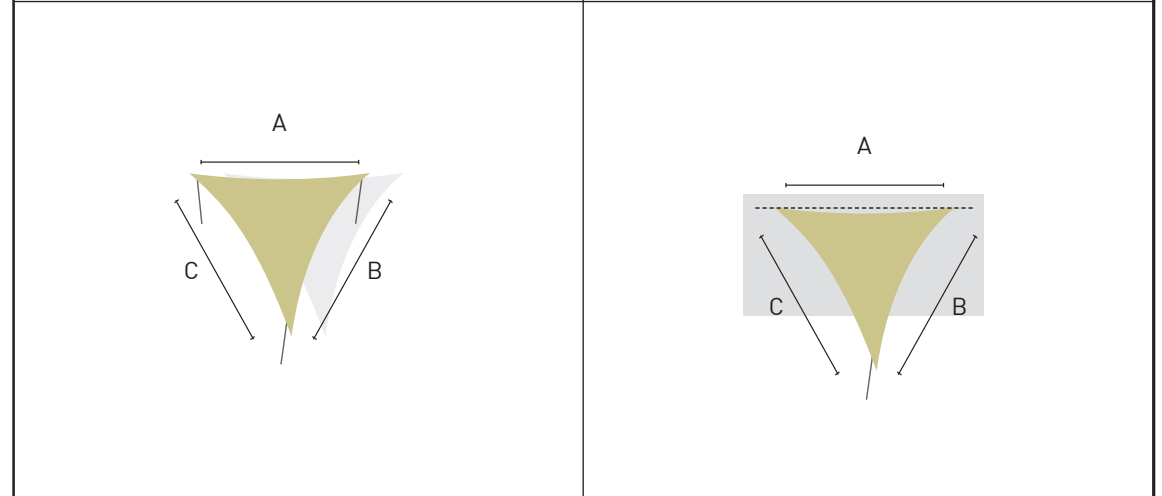
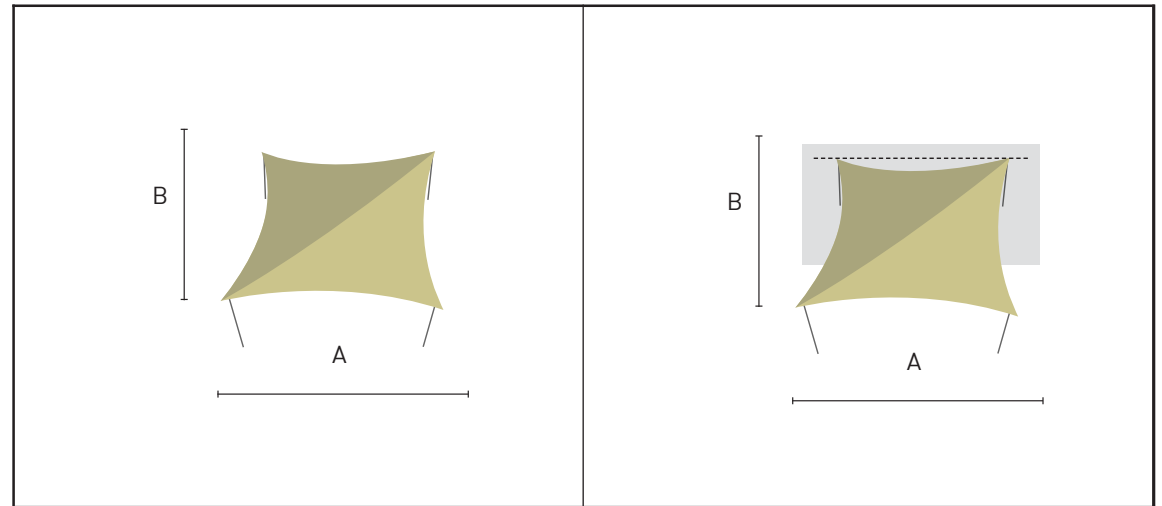

NOTE/NOTES

GENNIUS EASY SAILS E4

CLIENTE (timbro) CUSTOMER (stamp)

Quantità/Q.ty _____

Data consegna richiesta/Required delivery date _____ Riferimento/Reference _____

COLORAZIONI/COLOURS
STRUTTURA/STRUCTURE

- | | |
|---|--|
| <input type="checkbox"/> Bianco
White | <input type="checkbox"/> Antracite
Anthracite |
| <input type="checkbox"/> Silver
Silver | <input type="checkbox"/> Bronzo
Bronze |

DIMENSIONI/DIMENSIONS

(A) cm _____ (B) cm _____

- | | |
|--|---|
| <input type="checkbox"/> N° Pali
N° Poles _____ | <input type="checkbox"/> N° Supporti parete
N° wall supports _____ |
|--|---|

TESSUTO/FABRIC

- | | |
|---|---|
| <input type="checkbox"/> TEXTILENE cod. _____ | <input type="checkbox"/> Dacron Laminato
Rolled Dacron |
| <input type="checkbox"/> SUMBRELLA cod. _____ | <input type="checkbox"/> TENTMESH cod. _____ |

ALTEZZA PALI/HEIGHT POLES

- 2,8 MT 3,2 MT

OPTIONAL

- | | | | |
|--|--------------------|---|--------------------|
| <input type="checkbox"/> Supporto 75° per palo
75° support for pole | Q.tà _____
Q.ty | <input type="checkbox"/> Carter per supporti
Carter for supports | Q.tà _____
Q.ty |
|--|--------------------|---|--------------------|

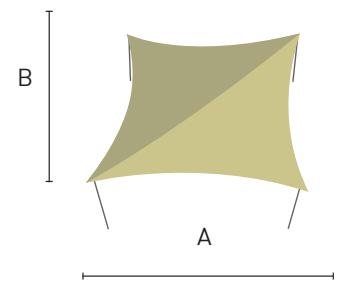
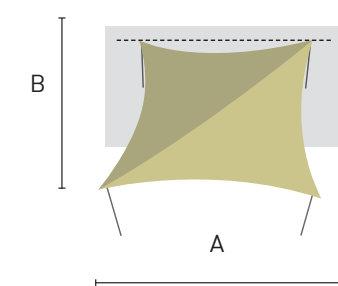
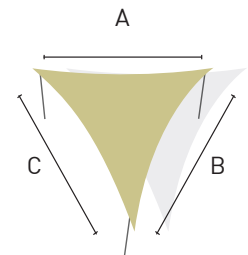
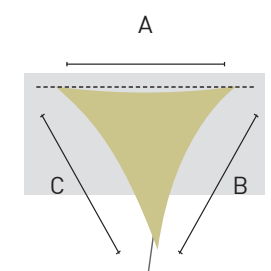
	
	
<p>NOTE/NOTES</p> <hr/> <hr/> <hr/> <hr/> <hr/> <hr/> <hr/> <hr/> <hr/> <hr/>	

TIMPANI/GABLES

CLIENTE (timbro)
CUSTOMER (stamp)

Quantità lato destro*/Quantity right side*

Quantità lato sinistro*/Quantity left side*

Riferimento/Reference

Data consegna richiesta
Required delivery date

TELO TIMPANO/GABLE FABRIC

PVC PRECONSTRAINT 602 oscurante Bianco Opaco
black out matt white

PVC PRECONSTRAINT 602 oscurante Avorio Opaco
black out matt ivory

PVC PRECONSTRAINT 602 Bianco
White

PVC PRECONSTRAINT 602 Avorio
Ivory

SOLTIS 92 cod. _____

CRISTAL

Altro/Other _____

POLICARBONATO/POLYCARBONATE

Trasparente/translucent

Opalino/white

Bronzo/bronze

VETRO/GLASS

* vista frontale/*Frontal side

NOTE/NOTES

A1

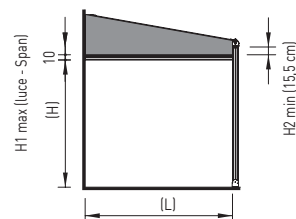

A100

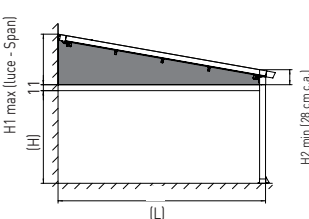

DIMENSIONI/DIMENSIONS

Larghezza
Width (L) cm

Altezza
Height (H) cm

Altezza 1
Height 1 (H1) cm

Altezza 2
Height 2 (H2) cm

COLORI PROFILI/PROFILE COLOURS

Colore - Colour: _____

A2C

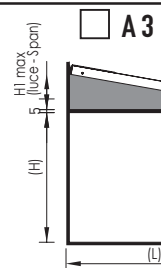

A3

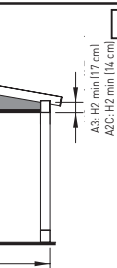

XTESA

DIMENSIONI/DIMENSIONS

Larghezza
Width (L) cm

Altezza
Height (H) cm

Altezza 1
Height 1 (H1) cm

Altezza 2
Height 2 (H2) cm

COLORI PROFILI/PROFILE COLOURS

Colore - Colour: _____

A2L

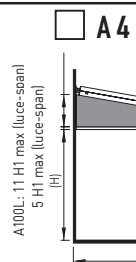

A4

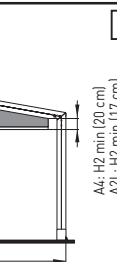

A100 L

DIMENSIONI/DIMENSIONS

Larghezza
Width (L) cm

Altezza
Height (H) cm

Altezza 1
Height 1 (H1) cm

Altezza 2
Height 2 (H2) cm

COLORI PROFILI/PROFILE COLOURS

Colore - Colour: _____

COLORE LEGNO/WOODEN EFFECT

Colore - Colour: _____

L1-S

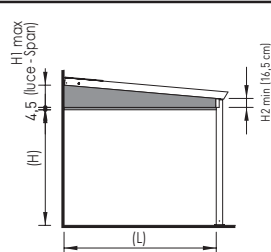

DIMENSIONI/DIMENSIONS

Larghezza
Width (L) cm

Altezza
Height (H) cm

Altezza 1
Height 1 (H1) cm

Altezza 2
Height 2 (H2) cm

COLORI PROFILI/PROFILE COLOURS

Colore - Colour: _____

COLORE LEGNO/WOODEN EFFECT

Colore - Colour: _____

L2

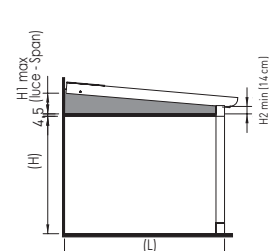

DIMENSIONI/DIMENSIONS

Larghezza
Width (L) cm

Altezza
Height (H) cm

Altezza 1
Height 1 (H1) cm

Altezza 2
Height 2 (H2) cm

COLORI PROFILI/PROFILE COLOURS

Colore - Colour: _____

COLORE LEGNO/WOODEN EFFECT

Colore - Colour: _____

CLIENTE (timbro) CUSTOMER (stamp)

Quantità/Q.ty _____

Riferimento/Reference _____

Data consegna richiesta/Required delivery date _____

MODELLO/MODEL

- Vertika Gennius GPR guida libera free guide 110
- Vertika Gennius GPZ guida zip zip guide 130 (solo GPR o GPZ) (GPR or GPZ only)
- Vertika Gennius GPZ T

TELO TENDA/AWNING FABRIC

- PVC PRECONSTRAINT 602 oscurante Bianco Opaco black out matt white
- PVC PRECONSTRAINT 602 oscurante Avorio Opaco black out matt ivory
- PVC PRECONSTRAINT 602 Bianco White
- PVC PRECONSTRAINT 602 Avorio Ivory
- SOLTIS 92 cod. _____
- CRISTAL Altro Other colour _____

COLORE PROFILI/PROFILE COLOURS

- RAL 9010 Bianco lucido White RAL 8014 Marron opaco Matt brown Nero inver Inver black
- RAL 1013 Avorio lucido Ivory Altro Other colour _____

FINESTRE/WINDOWS

(Opzionale/Optional)

- Nessuna finestra Without window Con finestra* With window*

* Cristal

- Tutto cristal All cristal

OPTIONAL

- Steccatura (solo GPR) Fencing (GPR only) Frangivento (solo GPR) Windbreak (GPR only)
- Frangitratta (solo GPR 130) Windbreak (130 GPR only) Guida compensata (solo GPZ) Balanced guide (GPZ only)
- Arganello 8:1 fine corsa Winch 8:1 with limit switch Steck System

NOTE/NOTES

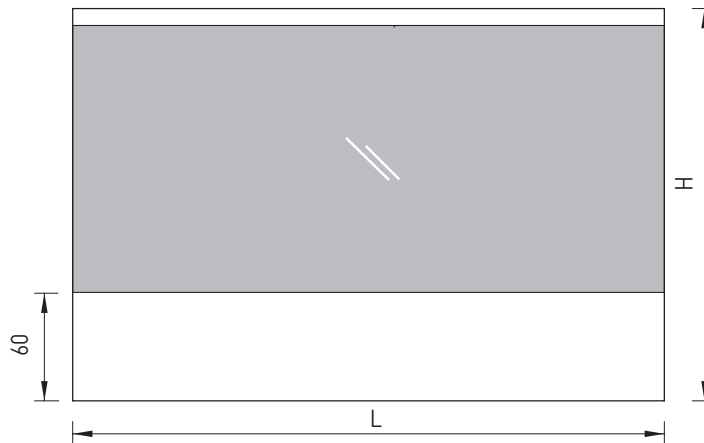

MOVIMENTAZIONE MOVEMENT

- Manuale con arganello Manual movement (solo GPR o GPZ) (GPR or GPZ only)
- Motore via cavo (senza pulsantiera) Motor by cable (without keyboard) KE SOMFY
- Motorizzazione KE KE Motorization RTS
- Motorizzazione SOMFY SOMFY Motorization RTS IO
- Telecomando Remote control Monocanale Single channel Multicanale Multi-channel

Q.tà Q.ty	Larghezza (L) cm Width (L) cm	Altezza (H) cm Height (H) cm	Lato manovra*/Motore* Side gear box*/motor*		Misura asta Crank rod measure
			Destro/Right	Sinistro/Left	
N _____	_____ cm	_____ cm	<input type="checkbox"/>	<input type="checkbox"/>	_____ cm
N _____	_____ cm	_____ cm	<input type="checkbox"/>	<input type="checkbox"/>	_____ cm
N _____	_____ cm	_____ cm	<input type="checkbox"/>	<input type="checkbox"/>	_____ cm
N _____	_____ cm	_____ cm	<input type="checkbox"/>	<input type="checkbox"/>	_____ cm
N _____	_____ cm	_____ cm	<input type="checkbox"/>	<input type="checkbox"/>	_____ cm
N _____	_____ cm	_____ cm	<input type="checkbox"/>	<input type="checkbox"/>	_____ cm

* Vista interna
* Internal view

**MONTANTI DI ACCOPIAMENTO:
JOINING POSTS:**

Modello _____ cm _____
Model _____
Misura _____ cm _____
Measure _____
Quantità _____ cm _____
Quantity _____

PORTE/DOORS

CLIENTE (timbro) CUSTOMER (stamp)

Modello/model 1 anta/1 door 2 ante/2 doors

Quantità/Q.ty _____ Riferimento/Reference _____

Data consegna richiesta/Required delivery date _____

COLORAZIONI/COLOURS

- RAL 9010 Bianco White Nero Inver Inver black
- RAL 1013 Avorio Ivory Altro Other colour _____

OPTIONAL VERSIONE 1 ANTA/ OPTIONAL ONE DOOR

- Sopraluce Transom
- Serratura triplice Triple lock
- Maniglione antipanico ad un punto di chiusura Panic exit to a closing point
- Maniglione antipanico a tre punti di chiusura Panic exit with three locking points

OPTIONAL VERSIONE 2 ANTE/ OPTIONAL VERSION TWO DOORS

- Sopraluce Transom
- Serratura triplice Triple lock
- Maniglione antipanico a tre punti di chiusura Panic exit with three locking points
- Maniglione antipanico a cinque punti di chiusura Panic exit with five locking points

1 ANTA - 1 DOOR

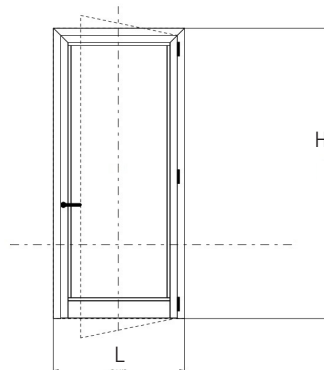

DIMENSIONI/DIMENSIONS

Larghezza * Width* (L) cm _____

Altezza* Height* (H) cm _____

Quantità Quantity Nr. _____

2 ANTE - 2 DOORS

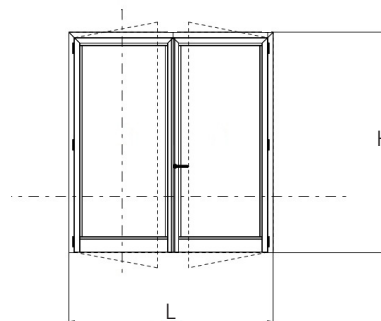

DIMENSIONI/DIMENSIONS

Larghezza * Width* (L) cm _____

Altezza* Height* (H) cm _____

Quantità Quantity Nr. _____

NOTE/NOTES

PARAPETTO/BALUSTRADE

CLIENTE (timbro) CUSTOMER (stamp)

Quantità/Q.ty _____ Riferimento/Reference _____

Data consegna richiesta/Required delivery date _____

COLORAZIONI/COLOURS

- | | | |
|---|---|--|
| <input type="checkbox"/> RAL 9010 Bianco
White | <input type="checkbox"/> RAL 8014 Marrone opaco
Matt brown | |
| <input type="checkbox"/> RAL 1013 Avorio
Ivory | <input type="checkbox"/> Nero Inver
Inver black | <input type="checkbox"/> Altro _____
Other colour |

ACCESSORI/ACCESSORIES

- | | | | |
|--|-----------|---|-----------|
| <input type="checkbox"/> Nr 2 supporti a terra standard
Nr 2 standard ground supports | nr. _____ | <input type="checkbox"/> Nr 2 connessioni rette
Nr 2 straight connection | nr. _____ |
| <input type="checkbox"/> Nr 2 supporti a terra piani
Nr 2 flat ground supports | nr. _____ | <input type="checkbox"/> Nr 2 connessioni a muro
Nr 2 wall connection | nr. _____ |
| <input type="checkbox"/> Nr 2 supporti con ruote
Nr 2 trolleys | nr. _____ | <input type="checkbox"/> Connessione interna profilo
Internal profile connection | nr. _____ |
| <input type="checkbox"/> Nr 2 "L" connessioni a 90°
Nr 2 "90° L connection" | nr. _____ | <input type="checkbox"/> Serratura
Locking | nr. _____ |

NOTE/NOTES

DIMENSIONI/DIMENSIONS

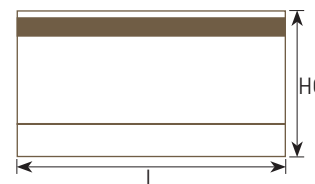

L* _____
Width* (L) cm _____

HC/HA* _____
Height* (H) cm _____

Quantità _____
Quantity Nr. _____



DISEGNO DELLA DISPOSIZIONE DEL PARAPETTO IN PIANTA LAYOUT OF PARAPET'S SYSTEM

VETRATE SCORREVOLI/GLASS WALL

CLIENTE (timbro) CUSTOMER (stamp)

Modello Gennius/Gennius model _____

Riferimento/Reference _____

Data consegna richiesta/Required delivery date _____

COLORAZIONI/COLOURS

- | | |
|---|--|
| <input type="checkbox"/> RAL 9010 Bianco
White | <input type="checkbox"/> Nero Inver
Inver black |
| <input type="checkbox"/> RAL 1013 Avorio
Ivory | <input type="checkbox"/> Altro
Other colour _____ |
| <input type="checkbox"/> RAL 8014 Marrone opaco
Matt brown | |

ACCESSORI/ACCESSORIES

- | | |
|---|-----------|
| <input type="checkbox"/> Maniglia ad incasso con chiave
Recessed handles drag with key | cp. _____ |
| <input type="checkbox"/> Profilo perimetrale ad angolo di tamponamento
Perimetric angular plugging profile | ml. _____ |
| <input type="checkbox"/> Vetrate riscaldanti
Glass heating | nr. _____ |

NOTE/NOTES

2 ANTE - 2 VIE/2 DOORS - 2 GUIDES

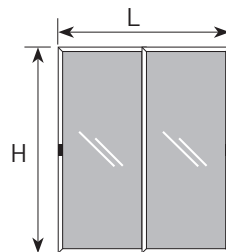

DIMENSIONI/DIMENSIONS

Larghezza *
Width* (L) cm _____

Altezza*
Height* (H) cm _____

Quantità
Quantity Nr. _____

3 ANTE - 3 VIE/3 DOORS - 3 GUIDES

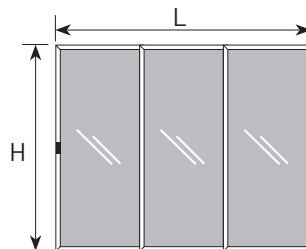

DIMENSIONI/DIMENSIONS

Larghezza *
Width* (L) cm _____

Altezza*
Height* (H) cm _____

Quantità
Quantity Nr. _____

4 ANTE - 2 VIE/4 DOORS - 2 GUIDES

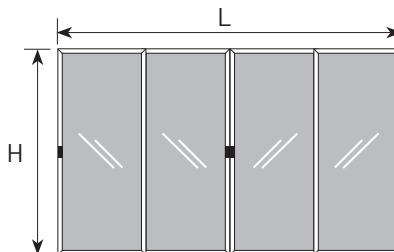

DIMENSIONI/DIMENSIONS

Larghezza *
Width* (L) cm _____

Altezza*
Height* (H) cm _____

Quantità
Quantity Nr. _____

6 ANTE - 3 VIE/6 DOORS - 3 GUIDES

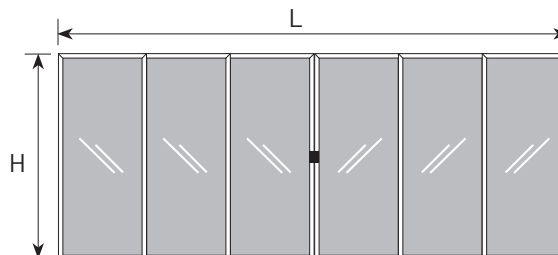

DIMENSIONI/DIMENSIONS

Larghezza *
Width* (L) cm _____

Altezza*
Height* (H) cm _____

Quantità
Quantity Nr. _____



VETRATE AD IMPACCHETTAMENTO FOLDING GLASS DOORS

CLIENTE (timbro) CUSTOMER (stamp)

Modello / model con guida With ground guides senza guida Without ground guides

Quantità/Q.ty _____ Riferimento/Reference _____

Data consegna richiesta/Required delivery date _____

COLORAZIONI/COLOURS

RAL 9010 Bianco White RAL 8014 Marrone opaco Matt brown
 RAL 1013 Avorio Ivory Nero Inver Inver black Altro Other colour _____

ACCESSORI/ACCESSORIES

Maniglia con chiave Handles drag with key nr. _____
 Guida inferiore ad incasso* Bottom rail flush nr. _____
 Doppia apertura* Double opening nr. _____

* Con guide a terra/ * with ground guides

NOTE/NOTES

DIMENSIONI/DIMENSIONS

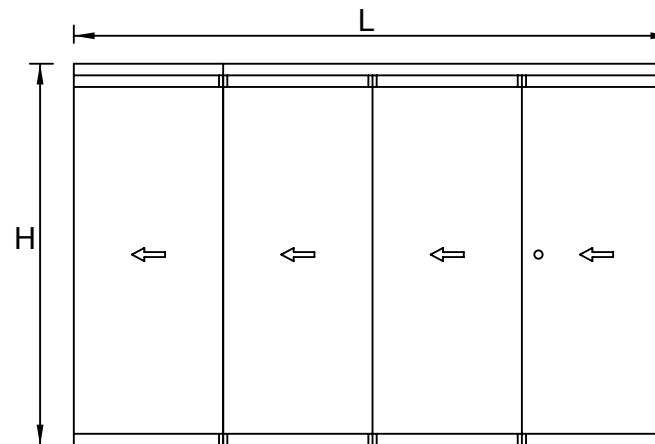

Larghezza* Width* (L) cm _____
 Altezza* Height* (H) cm _____
 Quantità Quantity Nr. _____

DISEGNO DELLA VETRATA IN PIANTA GLASS DOOR PLAN